

#whdentalwerk



video.wh.com

Now at  
your dealer  
or [wh.com](http://wh.com)



# Product catalogue

# 2024

---

valid from 01.01.2024

# Explanation of symbols

 with ring LED+ light

 with LED+ light

 with LED light

 with light

 without light

 integrated spray

 external spray

 without spray

 thermo washer disinfectable

 sterilizable

 disposable article

 latex-free

 foot control with cable

 wireless foot control

# Table of contents

Restoration & Prosthetics	4-29
Drive	30-41
Endodontics	42-47
Prophylaxis & Periodontology	48-87
Oral surgery & Implantology	88-129
Sterilization, Hygiene & Maintenance	130-189
Dental laboratory	190-195
Osstell	196-199
Built-in Solutions	200-207

# Important information

- › Pictures are for illustrative purposes only. Additional equipment and accessories shown are not included as standard.
- › KaVo Multiflex®, NSK Mach®, NSK QD-J®, BienAir Unifix® and Sirona® are trademarks of third parties not affiliated with W&H Dentalwerk Bürmoos GmbH

# Synea Vision

## Explanation of Symbols

 led+ with ring LED+ light

 led+ with LED+ light

 with light

 integrated spray

 thermo washer  
disinfectable

 sterilizable



## The new range of Synea Vision turbine handpieces:

Innovative technology and a comprehensive range of products for the highest demands.



led+

Ring LED+, 5-fold spray, 26 W,  
head size Ø 13mm

**TK-100 L**  
REF 30021000



led+

Ring LED+, 5-fold spray, 24 W,  
head size Ø 11,5mm

**TK-98 L**  
REF 30019000



led+

Ring LED+, 5-fold spray, 21 W,  
head size Ø 10 mm

**TK-97 L**  
REF 30017000



led+

LED+, 5-fold spray, 14 W,  
head size Ø 9 mm

**TK-94 L**  
REF 30016000



Glass rod, 5-fold spray, 26 W,  
head size Ø 13 mm

**TK-100 LM**  
REF 30022000



Glass rod, 5-fold spray, 24 W,  
head size Ø 11,5 mm

**TK-98 LM**  
REF 30020000



Glass rod, 5-fold spray, 21 W,  
head size Ø 10 mm

**TK-97 LM**  
REF 30018000



Glass rod, 5-fold spray, 14 W,  
head size Ø 9 mm

**TK-94 LM**  
REF 30031000

Roto Quick couplings RQ-24 / RQ-34 see page 118

\* W&H coupling RM-34 LED see page 119



1:5, 5-fold spray, head size Ø 9,5mm,  
press-button chuck system for FG burs  
Ø 1,6 mm, glass rod

**WK-99 LT**  
(ceramic ball bearings)  
REF 30023000



1:4, 3-fold spray, head size Ø 10,7mm,  
press-button chuck system for FG burs,  
Ø 1,6mm, glass rod

**WK-900 LT**  
(ceramic ball bearings)  
REF 30418000



1:4,5, 5-fold spray, head size Ø 9,1 mm,  
press-button chuck system for FG burs  
Ø 1,6 mm, glass rod

**WK-93 LT**  
(ceramic ball bearings)  
REF 30024000



1:1, single spray, head size Ø 9,5 mm,  
press-button chuck system for contra-angle  
burs Ø 2,35 mm, glass rod

**WK-56 LT**  
REF 30025000



8:1, single spray, head size Ø 9,5mm,  
press-button chuck system for  
contra-angle burs Ø 2,35 mm, glass rod

**WK-86 LT**  
REF 30027000



2:1, single spray, head size Ø 9,5 mm,  
press-button chuck system for contra-angle  
burs Ø 2,35 mm, glass rod

**WK-66 LT**  
REF 30026000



1:1, single spray, Twist tension chuck system  
for handpiece and contra-angle burs  
Ø 2.35 mm, glass rod

**HK-43 LT**  
REF 30028000



1:5, 5-fold spray, head size Ø 9,5mm,  
press-button chuck system for FG burs  
Ø 1,6 mm, glass rod

**WK-99 LT S**  
(ceramic ball bearings)  
REF 30215000



1:4,5, 5-fold spray, head size Ø 9,1 mm,  
press-button chuck system for FG burs  
Ø 1,6 mm, glass rod

**WK-93 LT S**  
(ceramic ball bearings)  
REF 30216000



1:1, single spray, head size Ø 9,5 mm,  
press-button chuck system for contra-angle  
burs Ø 2,35 mm, glass rod

**WK-56 LT S**  
REF 30217000







2:1, single spray, head size Ø 9,5 mm,  
press-button chuck system for contra-angle  
burs Ø 2,35 mm, glass rod

**WK-66 LT S**  
REF 30218000



# Synea Fusion

## Explanation of Symbols

- led+ with LED light
-  with light
-  without light
-  integrated spray
-  thermo washer disinfectable
-  sterilizable



**Synea Fusion –**  
 be assured with proven  
 Synea quality  
 at an outstanding price

Turbine handpieces



Quattro Spray, 21 W,  
head size Ø 11,5 mm,

**TG-98 L**  
(for RQ-24 / RQ-34\*)  
REF 30001000

**TG-98 L RM**  
(standard 6-hole connection)  
REF 30198000

**TG-98 LW**  
for RA-24 / RA-25  
REF 30202001

**TG-98**  
(for RQ-03 / RQ-04 / RQ-14\*)  
REF 30002000







Quattro Spray, 18 W,  
head size Ø 10 mm,

**TG-97 L**  
(for RQ-24 / RQ-34\*)  
REF 30004000

**TG-97 L RM**  
(standard 6-hole connection)  
REF 30197000

**TG-97 LW**  
(for RA-24 / RA-25)  
REF 30201001

**TG-97**  
(for RQ-03 / RQ-04 / RQ-14\*)  
REF 30005000





\* Roto Quick couplings see page 116

turbine handpieces with NSK connection



Glass rod,  
Quattro Spray, 21 W,  
head size Ø 11,5 mm

**TG-98 L N**  
REF 30200000



Glass rod,  
Quattro Spray, 18 W,  
head size Ø 10 mm

**TG-97 L N**  
REF 30199000



turbine handpieces with Multiflex® connection\*



Glass rod,  
Quattro Spray, 21 W,  
head size Ø 11,5 mm

**TG-98 LM**  
REF 30003000



Glass rod,  
Quattro Spray, 18 W,  
head size Ø 10 mm

**TG-97 LM**  
REF 30006000



\* W&H coupling RM-34 LED see page 119



1:5, Quattro Spray, head size Ø 9,5 mm, press-button chuck system for FG burs Ø 1,6 mm, glass rod

**WG-99 LT**  
REF 30007000  
**WG-99 A**  
REF 30008000



1:1, single spray, head size Ø 9,5 mm, press-button chuck system for contra-angle burs Ø 2,35 mm, glass rod

**WG-56 LT**  
REF 30009000  
**WG-56 A**  
REF 30010000



1:4, 3-fold spray, head size Ø 10,7mm, press-button chuck system for FG burs, Ø 1,6mm, glass rod

**WG-900 LT**  
REF 30459000



1:4, 3-fold spray, head size Ø 10,7mm, press-button chuck system for FG burs, Ø 1,6mm

**WG-900 A**  
REF 30460000



2:1, single spray, head size Ø 9,5 mm, press-button chuck system for contra-angle burs Ø 2,35 mm, glass rod

**WG-66 LT**  
REF 30011000  
**WG-66 A**  
REF 30012000



1:1, press-button chuck system, head size Ø 9,5 mm, for FG burs Ø 1.6 mm, glass rod

**WG-57 LT**  
REF 30212001



1:1, single spray, Twist tension chuck system for handpiece and contra-angle burs Ø 2.35 mm

**HG-43 A**  
REF 30013000



Profin® contra-angle handpiece 2:1, single spray, stroke 1.1 mm, for Dentatus tips

**WG-67 LT**  
REF 30084000  
**WG-67 A**  
REF 30085000





# Alegra

## Explanation of Symbols

- led+ with LED+ light
- led with LED light
-  with light
-  without light
-  integrated spray
-  without spray
-  thermo washer disinfectable
-  sterilizable



**Discover the new Alegra turbines with extremely quiet operation for daily use in your practice.**

Designed to meet your needs with state-of-the-art technology. Made in Austria: For your best treatment results.

turbine handpieces with ceramic ball bearings and light



led  

Triple spray, 18 W,  
head size Ø 12.2 mm

**TE-98 LQ**  
REF 30067000



led  

Triple spray, 16 W,  
head size Ø 10.4 mm

**TE-97 LQ**  
REF 30066000

Roto Quick couplings with generator for Alegra turbine handpieces TE-97/98 LQ



Borden 2-hole connection, generator and water filter with resuction stop

**RQ-53**  
REF 10405300



standard 4-hole connection, generator and water filter with resuction stop

**RQ-54**  
REF 10405400

Turbine handpieces with ceramic ball bearings, without light



 



Triple spray, 18 W,  
head size Ø 12.2 mm

**TE-98**  
(for RQ-03 / RQ-04 / RQ-14\*)  
REF 30071000

**TE-98 BC**  
(Borden 2-hole connection)  
REF 30072000

**TE-98 RM**  
(Standard 4-hole connection)  
REF 30073000



Triple spray, 16 W,  
head size Ø 10.4 mm

**TE-97**  
(for RQ-03 / RQ-04 / RQ-14\*)  
REF 30068000

**TE-97 BC**  
(Borden 2-hole connection)  
REF 30069000

**TE-97 RM**  
(Standard 4-hole connection)  
REF 30070000

Turbine handpieces with steel ball bearings, without light



Single spray, 18 W,  
head size Ø 12.2 mm

**TE-95 BC**  
(Borden 2-hole connection)  
REF 30074000

**TE-95 RM**  
(Standard 4-hole connection)  
REF 30075000

\* Roto Quick couplings see page 116

Contra-angle and straight handpieces, sleeve outer diameter 20 mm



1:1, press-button chuck system, head size Ø 10.1 mm, for contra-angle burs Ø 2.35 mm

**WE-56**  
REF 30116000



1:1, press-button chuck system, head size Ø 10.1 mm, for FG burs Ø 1.6 mm

**WE-57**  
REF 30117000



4:1, press-button chuck system, head size Ø 10.1 mm, for contra-angle burs Ø 2.35 mm

**WE-66**  
REF 30118000



1:1, Twist tension chuck system for handpiece and contra-angle burs Ø 2.35 mm

**HE-43**  
REF 30119000



1:4,5, triple spray, press-button chuck system, head size Ø 10.1 mm, for FG burs Ø 1.6 mm

**WE-99 LED G**  
REF 10259900



1:1, single spray, press-button chuck system, head size Ø 10.1 mm, for contra-angle burs Ø 2.35 mm

**WE-56 LED G**  
REF 10255600



4:1, single spray, press-button chuck system, head size Ø 10.1 mm, for contra-angle burs Ø 2.35 mm

**WE-66 LED G**  
REF 10256600

Contra-angle handpieces, with light and generator



1:1, press-button chuck system, head size Ø 10.1 mm, for contra-angle burs Ø 2.35 mm

**WE-56 T**  
REF 30120000



1:1, press-button chuck system, head size Ø 10.1 mm, for FG burs Ø 1.6 mm

**WE-57 T**  
REF 30121000



4:1, press-button chuck system, head size Ø 10.1 mm, for contra-angle burs Ø 2.35 mm

**WE-66 T**  
REF 30122000



1:1, Twist tension chuck system for handpiece and contra-angle burs Ø 2.35 mm

**HE-43 T**  
REF 30123000



1:1, press-button chuck system, head size Ø 10.1 mm, for contra-angle burs Ø 2.35 mm

**WE-56 T MW** Midwest handpiece connection\*  
REF 30124001

**WE-56 T SD** Star Dental handpiece connection\*\*  
REF 30127001



1:1, press-button chuck system, head size Ø 10.1 mm, for FG burs Ø 1.6 mm

**WE-57 T MW** Midwest handpiece connection\*  
REF 30125001

**WE-57 T SD** Star Dental handpiece connection\*\*  
REF 30128001



1:1, Twist tension chuck system for handpiece and contra-angle burs Ø 2.35 mm

**HE-43 T MW** Midwest handpiece connection\*  
REF 30126001

**HE-43 T SD** Star Dental handpiece connection\*\*  
REF 30129001

Contra-angle and straight handpieces, sleeve outer diameter 18 mm

\* W&H airmotors with Midwest handpiece connection: AM-20 MW RQ/ RM, AM-05 MW RQ/ RM (see page 124)

\*\* W&H airmotors with Star Dental handpieces connection: AM-20 SD RQ/ RM, AM-05 SD RQ/ RM (see page 125)

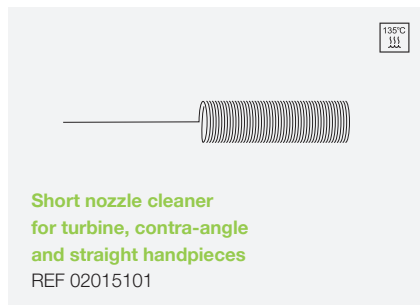

Parts available after sale for Alegra turbine handpieces

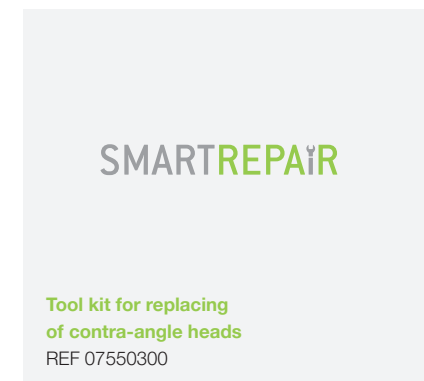
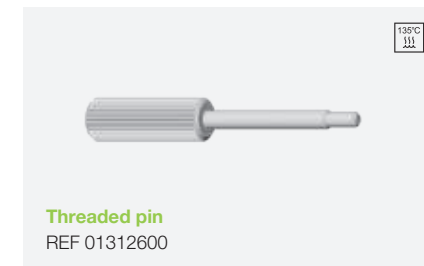
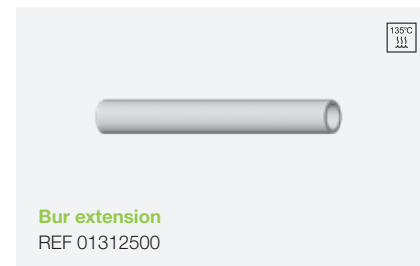

Parts available after sale for Alegra contra-angle and straight handpieces

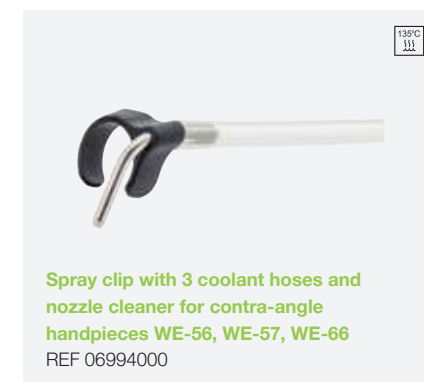

Accessories for Alegra contra-angle and straight handpieces

Low-speed set



- Consists of:
- › WE-56 T
  - › HE-43 T
  - › AM-20 RM

**Low-speed set 1 RM**  
REF 90000123



- Consists of:
- › WE-56 T
  - › HE-43 T
  - › AM-20 BC

**Low-speed set 1 BC**  
REF 90000124

High-speed set



- Consists of:
- › TE-95 RM
  - › WE-56 T
  - › HE-43 T
  - › AM-20 RM
  - › Nozzle cleaner

**High-speed set 1 RM**  
REF 90000125



- Consists of:
- › TE-95 BC
  - › WE-56 T
  - › HE-43 T
  - › AM-20 BC
  - › Nozzle cleaner

**High-speed set 1 BC**  
REF 90000126

Accessories



Place for 17 turbine handpieces, contra-angle and straight handpieces, 3 micromotors, 2 couplings

**Transportation and presentation case, big**  
REF 06505300



Place for 7 turbine handpieces, contra-angle and straight handpieces

**Transportation and presentation case, small**  
REF 06240900

# Primea Advanced Air

## Explanation of Symbols

 with ring LED+ light

 with LED+ light

 with light

 integrated spray

 thermo washer  
disinfectable

 sterilizable



**Primea Advanced Air:**  
The world's first air-driven high-speed drive solution with an adjustable bur speed to provide constant removal rate, even with increasing pressure.

# Add-on



Turbine handpieces



led+

Ring LED+, up to 30 W  
5-fold spray, head size Ø 10 mm,  
press-button chuck system for FG burs  
Ø 1.6 mm

**RK-97 L**  
(Roto Quick connection\*)  
REF 30221000



led+

LED+, up to 30 W  
5-fold spray, head size Ø 10 mm,  
press-button chuck system for FG burs  
Ø 1.6 mm

**RG-97 L**  
(Roto Quick connection\*)  
REF 30222000

Add-on AF-100

- › AF-100 control unit basic  
60,000 – 320,000 rpm
- › Power supply  
100 – 240 V
- › Air supply hose  
Ø 6 mm
- › RQ-24
- › RG-97 L (LED+)



**Add-on AF-100**  
REF 90000143

Accessories for Add-on



**Tray**  
REF 07944590



**Add-on support**  
REF 07842200



**Display bracket**  
REF 07712700

\* Roto Quick couplings RQ-24 or RQ-34



# Roto Quick couplings

## Explanation of Symbols

led with LED light

with light

without light

integrated spray

sterilizable



The Roto Quick system coupling is a multi-faceted system interface, which connects any standardized turbine tubing to any W&H turbine or air scaler with Roto Quick connection.





Standard 6-hole connection

**RQ-24**  
REF 10402400



Standard 6-hole connection, adjustable spray

**RQ-34**  
REF 10403400



Borden 2(3)-hole connection

**RQ-03**  
REF 10400300



Standard 4-hole connection

**RQ-04**  
REF 10400400



Standard 4-hole connection, adjustable spray

**RQ-14**  
REF 10401400



Borden 2-hole connection, generator and water filter with resuction stop

**RQ-53**  
REF 10405300



Standard 4-hole connection, generator and water filter with resuction stop

**RQ-54**  
REF 10405400



Standard 6-hole connection, for Synea Fusion turbine handpiece TG-97/98 LW

**RA-24**  
REF 10402424



5-hole connection (with light), glass rod, for Synea Fusion turbine handpiece TG-97/98 LW

**RA-25**  
REF 10402525



Standard 6-hole connection, adjustable spray

**RM-34 LED**  
REF 10403410



**O-ring set**  
REF 07508900

Quick couplings with generator for Alegra turbine handpieces TE-97/98 LQ

Quick couplings for Synea Fusion turbine handpiece TG-97/98 LW

Coupling with LED light for KaVo Multiflex® connection

Parts available after sale

Quick couplings

# Air motors

## Explanation of Symbols

-  with LED light
-  with light (halogen)
-  without light
-  integrated spray
-  external spray
-  without spray
-  thermo washer disinfectable
-  sterilizable



\*can be used with Roto Quick couplings with light: RQ-24 / RQ-34 – see page 118

\*\*can be used with Roto Quick couplings: RQ-24 / RQ-34 / RQ-14 / RQ-03 / RQ-04 – see page 118



Roto Quick connection for contra-angle and straight handpieces with light for RQ-34 or RQ-24\*

**AM-25 LT**  
REF 10002500



Standard 6-hole connection, LED light, for contra-angle and straight handpieces with glass rod

**AM-25 L RM**  
REF 30102000



Roto-Quick connection for contra-angle and straight handpieces without light for RQ-14, RQ-03 or RQ-04\*\*

**AM-25 A**  
REF 10002501



Standard 4-hole fix connection, for contra-angle and straight handpieces without light

**AM-25 A RM**  
REF 30103000

With integrated spray sleeve outer diameter of 20mm



Borden 2(3)-hole fix connection, for contra-angle and straight handpieces without light

**AM-25 A BC**  
REF 30104000

With external spray sleeve outer diameter of 20mm



Standard 4-hole fix connection, for contra-angle and straight handpieces without light

**AM-25 E RM**  
REF 30105000



Borden 2(3)-hole fix connection, for contra-angle and straight handpieces without light

**AM-25 E BC**  
REF 30111000



Roto Quick connection, for contra-angle and straight handpieces without light, for Roto Quick couplings RQ-03, RQ-04 and RQ-14

**AM-25 RQ**  
REF 30399000



Standard 4-hole fix connection, for contra-angle and straight handpieces without light

**AM-25 RM**  
REF 30108000



Borden 2(3)-hole fix connection, for contra-angle and straight handpieces without light

**AM-25 BC**  
REF 30112000

Without spray sleeve outer diameter of 20mm

With external spray sleeve outer diameter of 18mm



Standard 4-hole fix connection, for contra-angle and straight handpieces without light

**AM-20 E RM**  
REF 30107000



Borden 2(3)-hole fix connection, for contra-angle and straight handpieces without light

**AM-20 E BC**  
REF 30109000



Roto Quick connection, for contra-angle and straight handpieces without light, for Roto Quick couplings RQ-03, RQ-04 and RQ-14

**AM-20 RQ**  
REF 30400000



Standard 4-hole fix connection, for contra-angle and straight handpieces without light

**AM-20 RM**  
REF 30106000

Without spray sleeve outer diameter of 18mm



Borden 2(3)-hole fix connection, for contra-angle and straight handpieces without light

**AM-20 BC**  
REF 30113000

Parts available after sale



**O-ring for air motors**  
**AM-25 L RM, AM-25 A RM, AM-25 A BC**  
3 pcs  
REF 01862300



**LED-ring for AM-25 L RM**  
REF 07389100

Air Motors compatible with Midwest handpiece connection\*



Roto Quick connection, for contra-angle and straight handpieces with Midwest handpiece connection, for RQ-03 or RQ-04

**AM-20 MW RQ**  
REF 30402000



Standard 4-hole fix connection, for contra-angle and straight handpieces with Midwest handpiece connection

**AM-20 MW RM**  
REF 30115001



Roto Quick connection, for contra-angle and straight handpieces with Midwest handpiece connection, 4:1 speed decreasing, for RQ-03 or RQ-04

**AM-05 MW RQ**  
REF 30404000



Standard 4-hole fix connection, for contra-angle and straight handpieces with Midwest handpiece connection, 4:1 speed decreasing

**AM-05 MW RM**  
REF 30220001

Air Motors compatible with Star Dental handpiece connection\*\*



Roto Quick connection, for contra-angle and straight handpieces with Star Dental handpiece connection, for RQ-03 or RQ-04

**AM-20 SD RQ**  
REF 30401000



Standard 4-hole fix connection, for contra-angle and straight handpieces with Star Dental handpiece connection

**AM-20 SD RM**  
REF 30114001



Roto Quick connection, for contra-angle and straight handpieces with Star Dental handpiece connection, 4:1 speed decreasing, for RQ-03 or RQ-04

**AM-05 SD RQ**  
REF 30403000



Standard 4-hole fix connection, for contra-angle and straight handpieces with Star Dental handpiece connection, 4:1 speed decreasing



**AM-05 SD RM**  
REF 30219001

\* W&H handpieces with Midwest handpiece connection: WE-56 T MW, WE-57 T MW, HE-43 T MW (see page 25)

\*\* W&H handpieces with Star Dental handpiece connection: WE-56 T SD, WE-57 T SD, HE-43 T SD (see page 25)

# Electric motor EM-12 L

## Explanation of Symbols

-  with light
-  integrated spray
-  sterilizable



Add-on MF-100 electric motor

- › MF-100 control unit basic 2,000 – 40,000 rpm
- › Power supply
- › EM-12 L electric motor max. 3 Ncm torque

**Add-on MF-100**  
REF 90000144



**Tray**  
REF 07944590



**Add-on support**  
REF 07842200

Accessories for Add-on

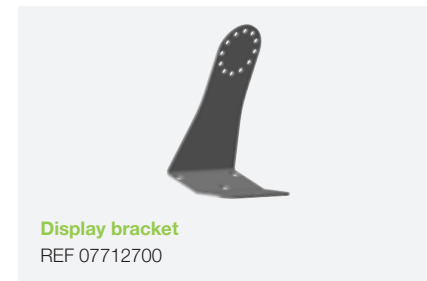

**Display bracket**  
REF 07712700

**Explanation of Symbols**

-  without light
-  without spray
-  thermo washer disinfectable
-  sterilizable

**The Endea contra-angle handpieces with their extra small heads provide even better access to the treatment area.**

Root canal preparation with 360° rotation is possible using both the Crown-down and the Single-length techniques.



Contra-angle handpieces



Endodontics

**Suitable inserts**

All root canal files, suitable for 360° rotation, particularly nickel-titanium files with shank diameter 2.35 mm, according to EN ISO 1797-1:1995.

**Re-order files**

Please re-order files at your responsible dental dealer or directly at Sendoline ([www.sendoline.com](http://www.sendoline.com)).

endo niti

# Endo NiTi

## Explanation of Symbols

-  without light
-  without spray
-  thermo washer disinfectable
-  sterilizable

**For the preparation of the root canal with rotating NiTi files.**



Contra-angle handpieces



70:1,  
press-button  
chuck system

**WD-73 M**  
REF 10217302



128:1,  
press-button  
chuck system

**WD-74 M**  
REF 10217402

## Suitable inserts

All root canal files, suitable for 360° rotation, particularly nickel-titanium files with shank diameter 2.35 mm, according to EN ISO 1797-1:1995.

## Re-order files

Please re-order files at your responsible dental dealer or directly at Sendoline ([www.sendoline.com](http://www.sendoline.com)).



# Endo Cursor

## Explanation of Symbols

-  without light
-  without spray
-  thermo washer disinfectable
-  sterilizable



## Endo Cursor



4:1, press-button chuck system,  
for root canal hand files with shank diameter  
3.6 – 4.0 mm

**EB-62**  
REF 12226201

Contra-angle handpiece

Endodontics

**For the mechanical  
preparation of the root  
canal with hand files.**



# Piezo Scaler Proxeo Ultra PB-510 / 520 / 530

## Explanation of Symbols



compatibility with  
pacemakers



The new Proxeo Ultra piezo scalers from W&H were developed in collaboration with prophylaxis professionals and really live up to their name. Exclusive user advantages allow ultra efficient treatment.

**PB-530**



**Set PB-5 L Q**

(with W&H Q-link - quick connection)

REF 90000258

**Set PB-5 L**

(with W&H / EMS / Mectron standard thread)

REF 90000257

**Set PB-5 L S**

(with W&H/Satelec/NSK thread)

REF 90000297

- › Control unit PB-530 with coolant tank, switch-mode power supply and 1.8 m supply hose
- › Foot control C-NW
- › Cable (pairing/charging) for C-NW

**Set PB-5 L Q**

- › Handpiece PB-5 L Q
- › Tips: 1UQ, 2UQ, 1PQ, 1IQ incl. tip exchanger with torque limitation

**Set PB-5 L**

- › Handpiece PB-5 L
- › Tips: 1U, 2U, 1P, 1I incl. tip exchanger with torque limitation

**Set PB-5 L S**

- › Handpiece PB-5 L S
- › Tips: 1US, 2US, 3US, 1PS incl. tip exchanger with torque limitation

**PB-520**



**Set PB-5 L Q**

(with W&H Q-link - quick connection)

REF 90000256

**Set PB-5 L**

(with W&H / EMS / Mectron standard thread)

REF 90000255

**Set PB-5 L S**

(with W&H/Satelec/NSK thread)

REF 90000296

- › Control unit PB-520 with coolant tank, switch-mode power supply and 1.8 m supply hose
- › Foot control C-NF

**Set PB-5 L Q**

- › Handpiece PB-5 L Q
- › Tips: 1UQ, 2UQ, 1PQ incl. tip exchanger with torque limitation

**Set PB-5 L**

- › Handpiece PB-5 L
- › Tips: 1U, 2U, 1P incl. tip exchanger with torque limitation

**Set PB-5 L S**

- › Handpiece PB-5 L S
- › Tips: 1US, 2US, 1PS incl. tip exchanger with torque limitation

**PB-510**



**Set PB-5 L Q**

(with W&H Q-link - quick connection)

REF 90000254

**Set PB-5 L**

(with W&H / EMS / Mectron standard thread)

REF 90000253

**Set PB-5 L S**

(with W&H/Satelec/NSK thread)

REF 90000295

- › Control unit PB-510 with coolant hose and filter, switch-mode power supply and 1.8 m supply hose
- › Foot control C-NF

**Set PB-5 L Q**

- › Handpiece PB-5 L Q
- › Tips: 1UQ, 2UQ, 1PQ incl. tip exchanger with torque limitation

**Set PB-5 L**

- › Handpiece PB-5 L
- › Tips: 1U, 2U, 1P incl. tip exchanger with torque limitation

**Set PB-5 L S**

- › Handpiece PB-5 L S
- › Tips: 1US, 2US, 1PS incl. tip exchanger with torque limitation

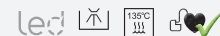

**PB-5 L Q**

(with W&H Q-link - quick connection)

REF 30327000



**PB-5 L (W&H)**

(with W&H / EMS / Mectron standard thread)

REF 30326000

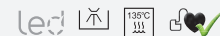



**PB-5 L S**

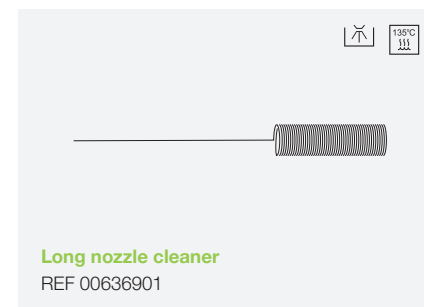
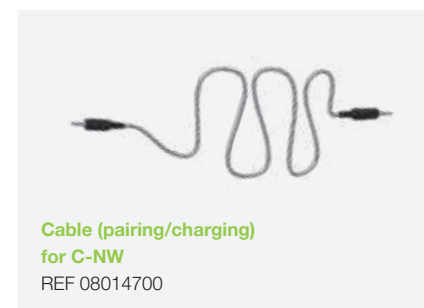
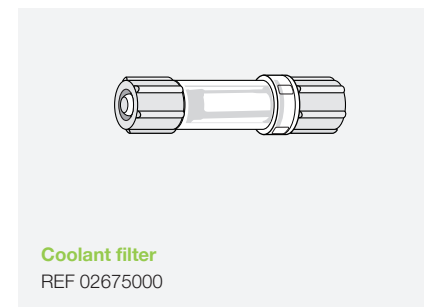
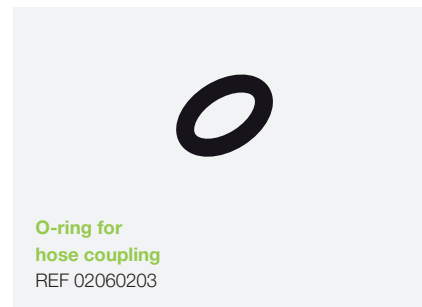
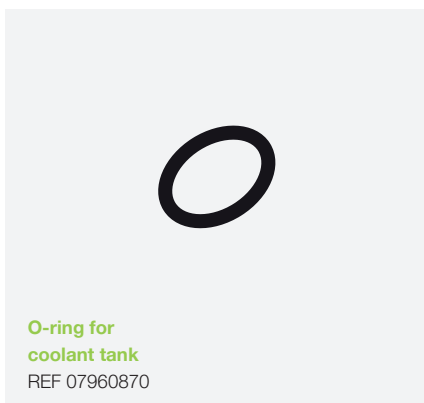

(with W&H/Satelec/NSK thread)

REF 30328000

Proxeo Ultra handpieces









- › Removal of sub- and supragingival calculus in all quadrants
- › The entire treatment can be carried out without the tedious job of changing tips

**Universal 1UQ with tip changer**  
 REF 08023920  
**Universal 1U with tip changer**  
 REF 05076200\*  
**Universal 1US with tip changer**  
 REF 07983820



- › Visibly longer and narrower 2U tips
- › Treatment of recall patients
- › For fine finishing
- › Fine scaling of supragingival calculus
- › Removal of plaque

**Universal 2UQ with tip changer**  
 REF 08023930  
**Universal 2U with tip changer**  
 REF 05076300\*  
**Universal 2US with tip changer**  
 REF 07983830





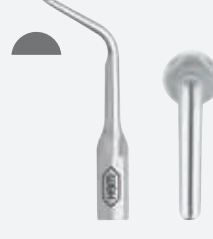

- › Slightly rounded and also particularly narrow and short
- › Fine scaling in the supragingival region
- › Ideal instrument for cleaning the interdental spaces

**Universal 3UQ with tip changer**  
 REF 08023940  
**Universal 3U with tip changer**  
 REF 05368200\*  
**Universal 3US with tip changer**  
 REF 07983850



- › Perfect tip for removing large areas of calculus

**Universal 4U with tip changer**  
 REF 05849201

Tip description:	
<b>1U</b> without S or Q	1U for W&H / EMS / Mectron standard thread
<b>1US</b>	1U for W&H / Satelec / NSK thread
<b>1UQ</b>	1U for W&H Q-link (quick connection)

\* also for Pyon 1 suitable









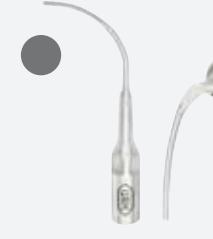

- › Removal of concretions in the subgingival region
- › Especially suitable for the treatment of deep periodontal pockets

**Periodontology 1PQ with tip changer**  
 REF 08023950  
**Periodontology 1P with tip changer**  
 REF 05370400\*  
**Periodontology 1PS with tip changer**  
 REF 07983860





- › Recommended for maintenance treatment on medium-depth to deep pockets as well as furcations

**Periodontology 3PrQ with tip changer**  
 REF 08023960  
**Periodontology 3Pr with tip changer**  
 REF 06364900  

**Periodontology 3PIQ with tip changer**  
 REF 08023980  
**Periodontology 3PI with tip changer**  
 REF 06365000



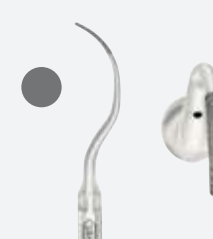

- › Diamond-coated tip for cleaning the root surface

**Periodontology 4PQ with tip changer**  
 REF 08024010  
**Periodontology 4P with tip changer**  
 REF 07965670  
**Periodontology 4PS with tip changer**  
 REF 07983870



- › Diamond-coated tip for cleaning furcations and concavities

**Periodontology 5PQ with tip changer**  
 REF 08024040  
**Periodontology 5P with tip changer**  
 REF 07965600

For supportive periodontitis treatment (SPT), recall and biofilm management

For initial periodontitis treatment and removal of concretions



For initial periodontitis treatment

- › Diamond-coated tip for cleaning the root surface

**Periodontology 5PrQ with tip changer**

REF 08024020

**Periodontology 5Pr with tip changer**

REF 07965660

**Periodontology 5PIQ with tip changer**

REF 08024030

**Periodontology 5PI with tip changer**

REF 07965620



Prophylaxis & Periodontology

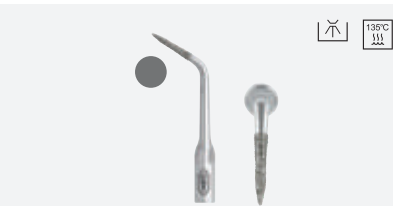

- › Expanding of fissures

**Restoration 1R with tip changer**

REF 05849401



- › Diamond-coated tip for veneer preparation
- › For clearly defined preparation margins
- › Maximum protection of the gingiva and the neighbouring tooth

**Restoration 2R with tip changer**

REF 06368400

For Restoration

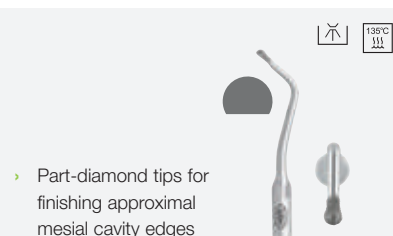

- › Part-diamond tips for finishing approximal mesial cavity edges

**Restoration 3Rm with tip changer**

REF 06368500

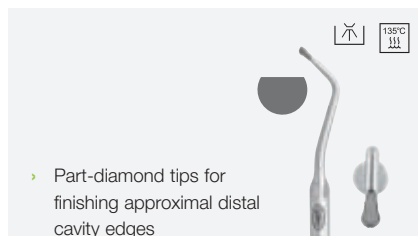

- › Part-diamond tips for finishing approximal distal cavity edges

**Restoration 3Rd with tip changer**

REF 06368600



For Endodontics

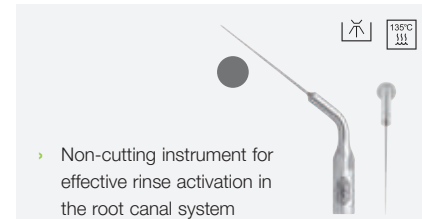

- › Non-cutting instrument for effective rinse activation in the root canal system

**Endodontie 1E with spanner**

REF 06367900

**Endodontie 1ES with spanner**

REF 07983880

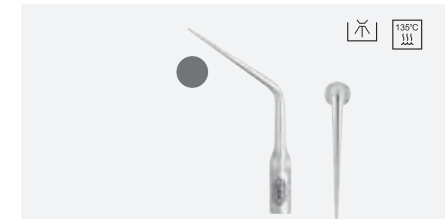

- › Tip for lateral thermal condensation of gutta-percha

**Endodontics 2E with spanner**

REF 06368000

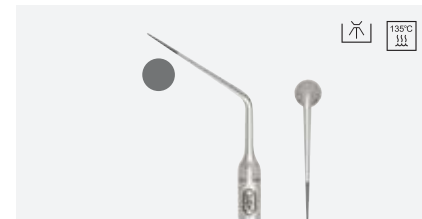

- › Removing of broke instruments in the root canal

**Endodontics 3E with spanner**

REF 06368100



- › Preparation of the pulp chamber

**Endodontics 4E with spanner**

REF 07812300

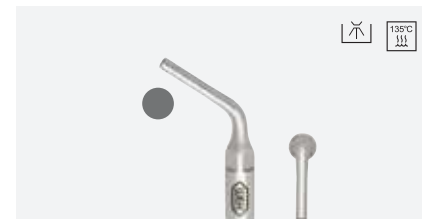

- › Vibrating and removal of root canal posts

**Endodontics 5E with tip changer**

REF 07812400



- › Removal of root canal fillings and root canal calcifications

**Endodontics 6E with spanner**

REF 07812500

Prophylaxis & Periodontology



**1U**   **3U**   **1P**

**Consists of:**

- > tip 1U, 3U, 1P (1 pc)
- > tip changer with torque limitation (3 pcs)
- > tip card

**Universal tip set**  
REF 05851800\*

**Consists of:**

- > tip 1I (3 pcs)
- > tip changer with torque limitation (3 pcs)

**Implant clean tip set (3x 1IQ)**  
REF 08026380

**Implant clean tip set (3x 1I)**  
REF 06370500

**1E**   **2E**   **3E**

**4E**   **5E**   **6E**

**Consists of:**

- > tip 1E, 2E, 3E, 4E, 5E, 6E (1 pc)
- > spanner (1 pc) for tip 1E, 2E, 3E, 4E, 6E
- > tip changer with torque limitation (1 pc) for tip 5E
- > tip card

**Endo tip set**  
REF 07812200

**TS-1**   **TW-1**

**TQ-1**

**Tip changer with torque limitation**

**TW-1: for tips with W&H thread (z.B. 1U, 2U)**  
REF 04982800

**TS-1: for tips with Satelec thread (z.B. 1US, 2US)**  
REF 07984290





**TQ-1: for tips with W&H Q-Link (quick connection)**  
REF 07985850





# Air scaler

## Explanation of Symbols

-  with light
-  without light
-  integrated spray
-  thermo washer disinfectable
-  sterilizable



### Fast, gentle, powerful.

The air-driven scaler with the integrated spray and two large optic outlets is ideal for the removal of plaque and calculus as well as cleaning root surfaces. The result: your patients feel better in general and more self-confident thanks to their clean teeth surfaces.

With Roto Quick connection\*



With tips 1AU, 2AU, 3AU and 1AP; tip changer, nozzle cleaner, small cleaning brush and tip card

**ZA-55**  
REF 10035501

\* Roto Quick couplings see page 116

With Multiflex® connection\*



With power regulation and tips 1AU, 2AU, 3AU and 1AP; tip changer, nozzle cleaner, small cleaning brush and tip card

**ZA-55 LM**  
REF 10035502



With tips 1AU, 2AU, 3AU and 1AP; tip changer, nozzle cleaner, small cleaning brush and tip card

**ZA-55 M**  
REF 10035503

\* coupling with LED light see page 119

With fixed connection



With tip 1AU (2 pcs), open-ended spanner, nozzle cleaner, small cleaning brush and tip card

**ZE-55 BC**  
REF 11015500



With tip 1AU (2 pcs), open-ended spanner, nozzle cleaner, small cleaning brush and tip card

**ZE-55 RM**  
REF 11015501

With Sirona® connection



With power regulation and tips 1AU, 2AU, 3AU and 1AP; tip changer, nozzle cleaner, small cleaning brush and tip card



**ZA-55 LS**  
REF 30227000

Tips



Universally applicable, also for curved molar surfaces with lingual inclination

**Tip 1AU with tip card**  
REF 07159700



For anterior teeth of the lower jaw, lingual surfaces and in cases of stubborn adhesion of thick, hard collars of dental calculus

**Tip 2AU with tip card**  
REF 07159800





For removing plaque from the neck of the tooth and removing nicotine stains

**Tip 3AU with tip card**  
REF 07159900



Removal of subgingival deposits, especially suitable for deep periodontal pockets

**Tip 1AP with tip card**  
REF 07009100

Tip for removal of subgingival deposits. Right-curved and leftcurved models available

**Tip 2APr with tip card**  
REF 05254400

Tip for removal of subgingival deposits. Right-curved and leftcurved models available

**Tip 2API with tip card**  
REF 05153300

With a diamond coating on the instrument tip for periodontal debridement of furcations and concavities.

**Tip 3AP with tip card**  
REF 05280200

Prophylaxis & Periodontology

Prophylaxis & Periodontology





**Tip changer**  
REF 07308100

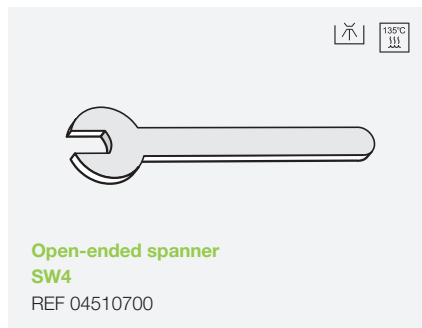

**Open-ended spanner  
SW4**  
REF 04510700

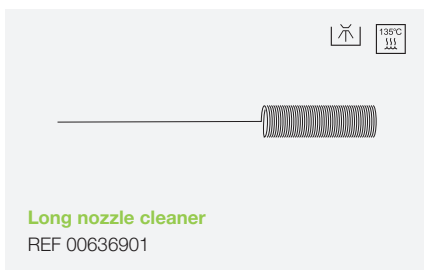

**Long nozzle cleaner**  
REF 00636901

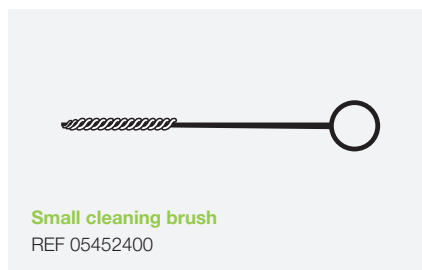

**Small cleaning brush**  
REF 05452400



**BC** **RM**  
**Coupling seal BC**  
REF 01000700  
**Coupling seal RM**  
REF 02207300

Parts available after sale



# Air Polishing System



## Proxeo Aura – Air Polishing System

This system with an air polishing handpiece and the corresponding powders allows you to remove supra- and subgingival biofilm, as well as stains efficiently, thoroughly and under control.



**Proxeo Aura prophyl set**

- › Air polishing handpiece
- › Spray head 120°
- › Prophylaxis Powder SOFT+ (250 g)
- › Accessories

**Connection**  
**PF-60** (W&H RotoQuick)  
 REF 08020760  
**PF-60 M** (Kavo Multiflex)  
 REF 08020770



**Proxeo Aura perio set**

- › Air polishing handpiece
- › Spray head 120°
- › Spray head perio
- › Subgingival perio tips (40 pcs)
- › Prophylaxis Powder SOFT+ (250 g)
- › Prophylaxis Powder SENSITIVE+ (160 g)
- › Accessories

**Connection**  
**PF-60** (W&H RotoQuick)  
 REF 08020761  
**PF-60 M** (Kavo Multiflex)  
 REF 08020771  
**PF-60 N** (NSK)  
 REF 08020781  
**PF-60 S** (Sirona)  
 REF 08020791



Sodium Bicarbonate, 4x250 g,  
 Ø Particle size: 40 µm

**Prophylaxis Powder SOFT+**  
 REF 08020870



Glycine, 2x160 g, Ø Particle size: 25 µm

**Prophylaxis Powder SENSITIVE+**  
 REF 08020890



**Spray head 120°**  
 REF 08020810



**Spray head short 120°**  
 REF 08020840



**Spray head 90°**  
 REF 08020800



**Spray head short 90°**  
 REF 08020830



**Spray head perio**  
 REF 08020820



**Spray head short perio**  
 REF 08020850

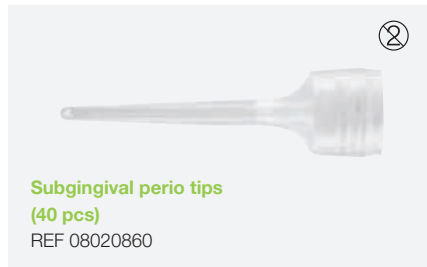

Prophylaxis & Periodontology

Prophylaxis & Periodontology

# Contra-angle and straight handpieces

## Explanation of Symbols

-  without light
-  without spray
-  thermo washer disinfectable
-  sterilizable
-  latex-free
-  disposable article

## Standard latch vs LatchShort



## Rotary polishing system

In modern dental treatment, the professional, mechanical removal of plaque and biofilm is an integral part of the prophylaxis workflow. With Proxeo TWIST, W&H offers a compact, easy to handle solution for everything you need, no matter whether it is cleaning, polishing or fluoridating!



4:1, contra-angle handpiece system  
LatchShort for all W&H LatchShort Prophy  
Cups / -Brushes

**WP-66 W**  
REF 30189000



soft / apple green  
LatchShort

**Prophy Cups**  
100 pcs REF 08003630



firm / dark green  
LatchShort

**Prophy Cups**  
100 pcs REF 07597900



cup-shaped  
soft / clear  
LatchShort

**Prophy Brushes**  
100 pcs REF 08003650



4:1, contra-angle handpiece system  
UNIVERSAL with Snap-on adaptor and key  
for all standard Screw-in cups, brushes and  
Snap-on adaptor

**WP-64 MU**  
REF 10216443



4:1, contra-angle handpiece system YOUNG  
with key, for YOUNG Screw-in cups and  
brushes

**WP-64 M**  
REF 10216403



**Snap-on adaptor for WP-64 MU**  
REF 04530600



**Key**  
REF 01957300



4:1, straight handpiece for disposable contra-  
angles with plastic shank, system Doriot

**HP-44 M**  
REF 10114403



4:1, contra-angle handpiece for all cups,  
brushes and Snap-on adaptor with  
2,35 mm shank

**WP-66 M**  
REF 30190000



4:1, straight handpiece for disposable contra- angles with plastic shank, system Doriot

**HP-44 T**  
REF 30191003



4:1, contra-angle handpiece system YOUNG with key, for YOUNG Screw-in cups and brushes

**WP-64 T**  
REF 30192002



4:1, straight handpiece (short) for disposable contra- angles with plastic shank, system Doriot

**HP-44 TS**  
REF 30313001



4:1, contra-angle handpiece (short) system YOUNG with key, for YOUNG Screw-in cups and brushes

**WP-64 TS**  
REF 30314001



4:1, straight handpiece (short) for disposable contra-angles with plastic shank, system Doriot

**HP-44 T MW Midwest handpiece connection\***  
REF 30079001



4:1, straight handpiece (short) for disposable contra-angles with plastic shank, system Doriot

**HP-44 T SD Star Dental handpiece connection\*\***  
REF 30080001



4:1 prophy handpiece with airmotor and RQ connection for disposable contra-angles with plastic shank, system Doriot

**Proxeo Set AP-20 RQ + HP-44 TS**  
REF 90000364



4:1 prophy contra-angle handpiece with airmotor and RQ connection for YOUNG Screw-in cups and brushes

**WP-64 TS + AP-20 RQ**  
REF 90000365



4:1 prophy handpiece with airmotor and RM connection for disposable contra-angles with plastic shank, system Doriot

**Proxeo Set AP-20 RM + HP-44 TS**  
REF 90000366



4:1 prophy contra-angle handpiece with airmotor and RM connection for YOUNG Screw-in cups and brushes

**WP-64 TS + AP-20 RM**  
REF 90000367

\* W&H airmotors with Midwest handpiece connection:  
AM-20 MW RQ/ RM, AM-05 MW RQ/ RM (see page 124)

\*\* W&H airmotors with Star Dental handpiece connection:  
AM-20 SD RQ/ RM, AM-05 SD RQ/ RM (see page 125)

# Cordless Polishing System



**Cordless polishing means polishing entirely without restrictions**

Twist and turn the ergonomically designed, light handpiece at will and change your position as needed. This allows you to access practically any angle during polishing and ensures a good view of the treatment site.





**PL-40 H Proxeo Twist Cordless System Doriot, consists of:**

- › PL-40 H handpiece drive incl. handpiece sleeve
- › Foot control C-NW
- › Charger with adaptor
- › Handpiece holder

REF 30317000



**PL-40 HW Proxeo Twist Cordless System LatchShort, consists of:**

- › PL-40 HW handpiece drive
- › PL-66 W for System LatchShort
- › Foot control C-NW
- › Charger with adaptor
- › Handpiece holder

REF 90000346



**PL-40 HW Proxeo Twist Cordless System Doriot, consists of:**

- › PL-40 HW handpiece drive
- › PL-44 for System Doriot
- › Foot control C-NW
- › Charger with adaptor
- › Handpiece holder

REF 90000348



**LATEX** (X)

soft / apple green, LatchShort

**Prophy Cups**  
100 pcs REF 08003630

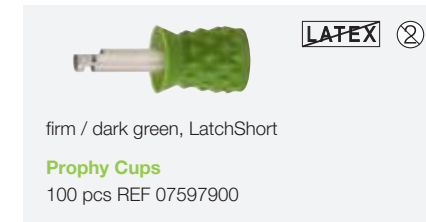

**LATEX** (X)

firm / dark green, LatchShort

**Prophy Cups**  
100 pcs REF 07597900

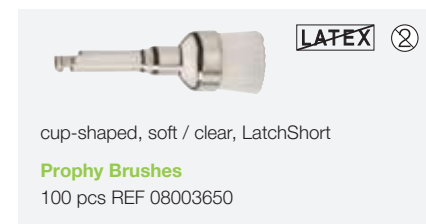

**LATEX** (X)

cup-shaped, soft / clear, LatchShort

**Prophy Brushes**  
100 pcs REF 08003650



**Prophy Angle Cups 105°**  
firm / dark green  
100 pcs  
REF 07979710



**Prophy Angle Cups 105°**  
soft / apple green  
100 pcs  
REF 07994950

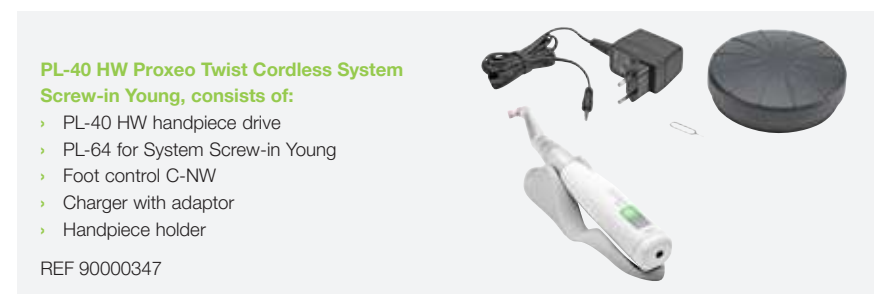

**PL-40 HW Proxeo Twist Cordless System Screw-in Young, consists of:**

- › PL-40 HW handpiece drive
- › PL-64 for System Screw-in Young
- › Foot control C-NW
- › Charger with adaptor
- › Handpiece holder

REF 90000347



**Drive handpiece PL-40 H**  
REF 07954780



**Foot control C-NW**  
REF 30316000



**Handpiece sleeve**  
REF 07918800



**Carrying case**  
REF 08025020

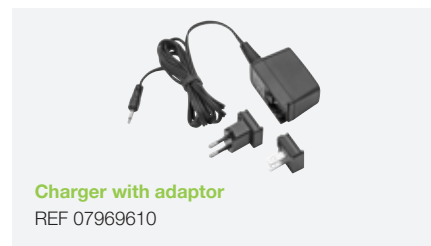

**Charger with adaptor**  
REF 07969610



**Handpiece holder**  
REF 05882600

Accessories

Prophylaxis & Periodontology



**PL-44**  
**for System Doriot**  
REF 30098000



**PL-64**  
**for System Screw-in Young**  
REF 30097000



**PL-66 W**  
**for System LatchShort**  
REF 30096000



**Drive handpiece**  
**PL-40 HW**  
REF 07947190



**Assistina adaptor for**  
**handpiece-/contra-angle head**  
REF 05204600

Prophylaxis & Periodontology

# Proxeo Combi-Set (Ultra & Twist Cordless)

proxeo<sup>TWIST</sup>

proxeo<sup>ULTRA</sup>



## Convenient, wireless and efficient:

From now on, the PB-530 Proxeo Ultra Piezo scaler and the Proxeo Twist Cordless System can be controlled using just a single wireless foot control. This not only makes it more convenient to operate, but also ensures more efficiency in working process.

All Proxeo Combi-Sets consist of:

**Cordless Polishing System Proxeo Twist**

- › PL-40 H handpiece drive  
incl. handpiece sleeve
- › Foot control C-NW
- › Charger with adaptor
- › Handpiece holder

**Control unit PB-530 with coolant tank**

**Switch-mode power supply**

**1.8 m supply hose**

**Cable (pairing/charging) for C-NW**



**Cordless Polishing System Proxeo Twist**

- › PL-40 HW handpiece drive
- › PL-66 W
- › Foot control C-NW
- › Charger with adaptor
- › Handpiece holder

**Control unit PB-530 with coolant tank**

**Switch-mode power supply**

**1.8 m supply hose**

**Cable (pairing/charging) for C-NW**



Handpiece PB-5 L Q

Tips: 1UQ, 2UQ, 1PQ, 1IQ

incl. tip exchanger with torque limitation

**Proxeo Combi-Sets:**

**Set PB-530, PB-5 L Q, PL-40 H**

REF 90000298

**Set PB-530, PB-5 L Q,**

**PL-40 HW, PL-66 W**

REF 90000356



Handpiece PB-5 L

Tips: 1U, 2U, 1P, 1I

incl. tip exchanger with torque limitation

**Proxeo Combi-Sets:**

**Set PB-530, PB-5 L, PL-40 H**

REF 90000299

**Set PB-530, PB-5 L,**

**PL-40 HW, PL-66 W**

REF 90000354



Handpiece PB-5 L S

Tips: 1US, 2US, 3US, 1PS

incl. tip exchanger with torque limitation

**Proxeo Combi-Sets:**

**Set PB-530, PB-5 L S, PL-40 H**

REF 90000301

**Set PB-530, PB-5 L S,**

**PL-40 HW, PL-66 W**

REF 90000358



# Implantmed SI-1023 / SI-1015



implantmed<sup>PLUS</sup>

**The W&H Implantmed offers the implantologist a drive unit for daily use**

This surgical unit can be safely used for oral-surgery procedures in implantology and maxillo-facial surgery.

**Implantmed Set, consists of:**

- › Control unit (230 V or 120 V)
- › Motor with 1.8 m cable (EM-19/EM-19 LC)
- › Including 5 clips
- › Foot control S-N2 / S-NW
- › Stand
- › Universal support
- › Mains cable
- › disposable irrigation tubings





**Foot control S-N2, motor without electrical contacts**  
**SI-1023 (230 V)**  
 REF 90000163  
**SI-1015 (120 V)**  
 REF 90000167



**Foot control S-N2, motor with electrical contacts**  
**SI-1023 (230 V)**  
 REF 90000165  
**SI-1015 (120 V)**  
 REF 90000169



**Foot control S-NW, motor without electrical contacts**  
**SI-1023 (230 V)**  
 REF 90000164  
**SI-1015 (120 V)**  
 REF 90000168



**Foot control S-NW, motor with electrical contacts**  
**SI-1023 (230 V)**  
 REF 90000166  
**SI-1015 (120 V)**  
 REF 90000170

Implantmed Sets



**Without foot control incl. CAN dongle, motor without electrical contacts**  
**SI-1023 (230 V)**  
 REF 90000171



**Implantmed SI-1023 (230 V)**  
 REF 30288000  
**Implantmed SI-1015 (120 V)**  
 REF 30289000



**EM-19 motor (without electrical contacts)**  
 1.8 m cable with 5 clips  
 REF 30185000

**EM-19 LC motor (with electrical contacts)**  
 1.8 m cable with 5 clips  
 REF 30281000

**EM-19 LC motor (with electrical contacts)**  
 3.5 m cable with 10 clips  
 REF 30281001

Oral surgery & Implantology

Implantmed Sets



**Transportation case for Implantmed Plus and Piezomed module**  
REF 07962790



**Foot control S-N2**  
REF 30285000



**Foot control S-NW with CAN dongle**  
REF 30264000



**CAN dongle**  
REF 07759700



**Universal support**  
REF 07721800





**Cassette**  
REF 04013500



# Piezomed Modul Classic / Plus SA-430 M / SA-435 M

## Explanation of Symbols

-  without light
-  thermo washer  
disinfectable
-  sterilizable



## The W&H Piezomed Module covers the cpl. Surgical workflow

A tailor-made solution for every user. Implantmed can be combined with the Piezomed module with a plug-and-play solution and covers several surgical applications.

**Piezomed Plus module 1.8 m**  
consisting of:

- › Module
- › Handpiece SA-40 L (1.8m)
- › Power supply and main cable
- › Support and stand
- › Instrument changer
- › 6 pcs. disposable irrigation tubes

**SA-435 M (1.8 m)**  
REF 90000350



**Piezomed Plus module 3.5 m**  
consisting of:

- › Module
- › Handpiece SA-40 L (3.5 m)
- › Power supply and main cable
- › Support and stand
- › Instrument changer
- › 6 pcs. disposable irrigation tubes

**SA-435 M (3.5 m)**  
REF 90000351



**Piezomed Classic module**  
consisting of:

- › Module
- › Handpiece SA-40 (1.8m)
- › Power supply and main cable
- › Support and stand
- › Instrument changer
- › 6 pcs. disposable irrigation tubes

**SA-430 M**  
REF 90000349



**Piezomed Handpiece with**

- › 1.8 m cable
- › LED Light and tip detection
- › Instrument changer

**SA- 40 L (1.8 m)**  
REF 30392000



**Piezomed Handpiece with**

- › 3.5 m cable
- › LED Light and tip detection
- › Instrument changer

**SA- 40 L (3.5 m)**  
REF 30392001



**Piezomed Handpiece with**

- › 1.8 m cable
- › No light and without tip detection
- › Instrument changer

**SA- 40 (1.8 m)**  
REF 30408000



**Disposable irrigation tubes**  
with Y-switch 2,2 m (6pcs)  
REF 08072750

**Disposable irrigation tubes**  
with Y-switch 3,8 m (6pcs)  
REF 08041710



**Transportation case for Implantmed Plus and Piezomed module**  
REF 07962790

446,-







**Instrument changer**  
REF 06276700

97,-

# Surgical straight and contra-angle handpieces

## Explanation of Symbols

-  with LED+ light
-  external spray
-  thermo washer disinfectable
-  sterilizable

with Mini LED+  
and W&H  
connection

20:1, hexagon chucking system, press-button chuck system, for surgical burs and cutters with contra-angled shank Ø 2.35 mm (shank hardness >50 HRC, >520 HV), optionally available Kirschner/Meyer internal cooling system

**WS-75 L**  
REF 30033000



1:1, press-button chuck system, for surgical burs and cutters with contra-angled shank Ø 2.35 mm

**WS-56 L**  
REF 30040000



1:2.7, 45° head, triple spray, press-button chuck system, for surgical burs and cutters with FG shank Ø 1.6 mm

**WS-91 L**  
REF 30049000



1:2.7, triple spray, press-button chuck system, for surgical burs and cutters with FG shank Ø 1.6 mm

**WS-92 L**  
REF 30043000



1:1, straight, lever chuck system, for surgical burs and cutters Ø 2.35 mm (also system Stryker)

**S-11 L**  
REF 30058000

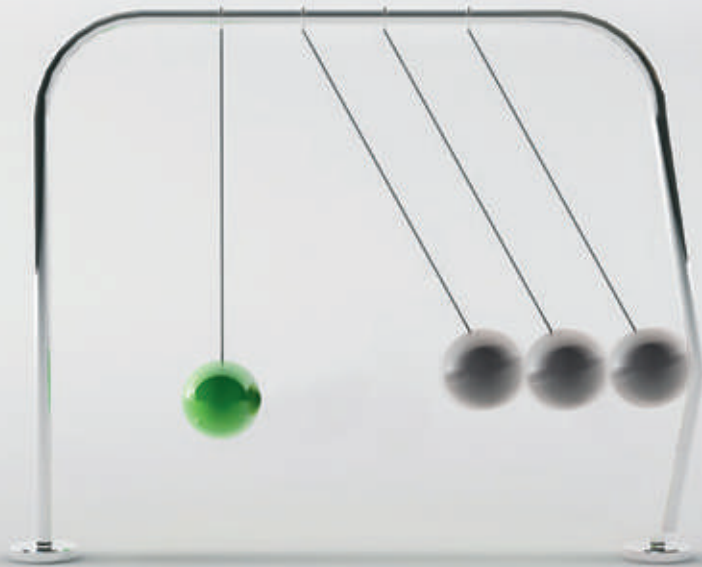

\*Product discontinuation August 2023

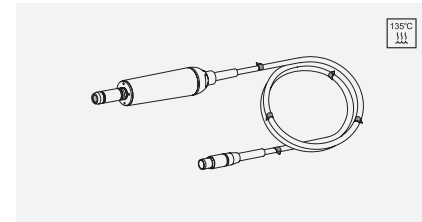

**Motor 1.8 m cable with 5 clips**  
REF 05513400

**Motor 3.5 m cable with 10 clips**  
REF 06205800



**Transportation case  
Elcomed SA-310**  
REF 07945930

446,-

Parts available after sales



**Fuse**  
**250 V - T1,6AH**  
REF 06352200



**USB stick**  
REF 06290700

# Implantmed Classic SI-915 / SI-923



The W&H Implantmed Classic offers the implantologist a surgical unit for daily use. The ergonomic design and ease of use ensures fatigue-free operation.

**Implantmed Classic Set, consisting of:**

- › Control unit (230 V or 120 V)
- › Motor EM-19 with 1.8 m cable
- › Incl. 5 hose clips
- › Foot control S-N2
- › Irrigant support
- › Universal support
- › Mains cable
- › disposable coolant hoses



**SI-923 (230 V)**  
REF 90000161

**SI-915 (120 V)**  
REF 90000162



**Foot control S-N2**  
REF 30285000



**EM-19 motor (without electrical contacts)**  
**1.8 m cable with 5 clips**  
REF 30185000

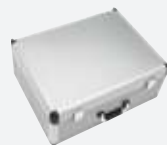

**Transportation case**  
**Implantmed SI-923 / SI-915**  
REF 07948730

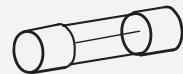

**Fuse T1,6 AH**  
REF 06352200

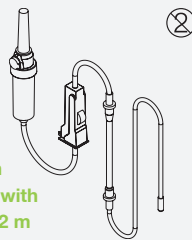

**Disposable irrigation tubing set for motor with 1,8 m cable, 6pcs, 2,2 m**  
REF 04363600

**Disposable irrigation tubing set for motor with 3,5 m cable, 6 pcs, 3,8 m**  
REF 04364100

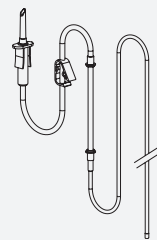

**Sterilizable irrigation tubing set for motor with 1,8 m cable 1 pcs, 2,2 m**  
REF 04719400



**Foot control S-NW with SPI dongle**  
REF 30264001

Attention! Not compatible with Implantmed Classic.



**SPI dongle (Implantmed SI-923, SI-915 (2011), Elcomed SA-310, Piezomed SA-320)**  
REF 07795800

Attention! Not compatible with Implantmed Classic.



**Variable foot control (Elcomed SA-310, Implantmed SI-923, SI-915) S-N1**  
REF 06202400

Attention! Not compatible with Implantmed Classic.

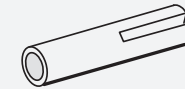

**Locking pin for motor**  
REF 04006800

Attention! Not compatible with Implantmed Classic.

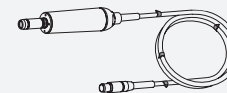

**Motor with 1.8 m cable incl. 5 clips**  
REF 06631600

Attention! Not compatible with Implantmed Classic.

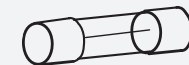

**Fuse T1,25AH**  
REF 06661800

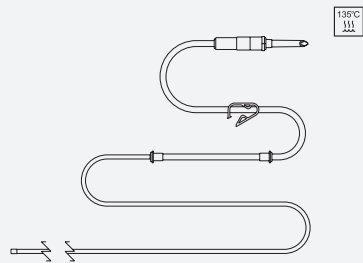

**Sterilizable irrigation tubing set 2.2 m, for motor with 1.8 m cable**  
REF 04976700

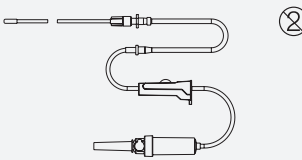

**Disposable irrigation tubing set, 6 set per carton, for motor with 2.2 m cable**  
REF 04365300

**Disposable irrigation tubing set, 6 set per carton, for motor with 3.8 m cable**  
REF 04365100



**Disposable irrigation tubing set for motor with 1,8 m cable**  
10 pcs, 2,2 m  
REF 00929300

**Disposable irrigation tubing for motor with 3,5 m cable**  
10 pcs, 3,8 m  
REF 00929400

Oral surgery & Implantology

Oral surgery & Implantology





# Surgical straight and contra-angle handpieces

## Explanation of Symbols

-  with LED+ light
-  without light
-  external spray
-  thermo washer disinfectable
-  sterilizable

**with and without Mini LED+**



20:1, hexagon, press-button chuck system, for surgical burs and cutters with contra-angled shank Ø 2.35 mm, optionally available Kirschner/Meyer internal cooling system

**WS-75 L G**  
REF 30032000



**WS-75**  
REF 30065000



1:1, press-button chuck system, for surgical burs and cutters with contra-angled shank Ø 2.35 mm

**WS-56 L G**  
REF 30039000



**WS-56**  
REF 30038000



1:2.7, 45° head, triple spray, press-button chuck system, for surgical burs and cutters with FG shank Ø 1.6 mm

**WS-91 L G**  
REF 30048000



**WS-91**  
REF 30047000



1:2.7, triple spray, press-button chuck system, for surgical burs and cutters with FG shank Ø 1.6 mm

**WS-92 L G**  
REF 30042000



**WS-92**  
REF 30041000



20:1, hexagon, press-button chuck system, for surgical burs and cutters with contra-angled shank Ø 2.35 mm, optionally available Kirschner/Meyer internal cooling system

**WS-75 E/KM (not dismantlable)**  
REF 10207550



## Surgical straight and contra-angle handpieces

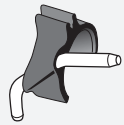

Spray clip black with external tube holder for Kirschner/Meyer internal cooling system

**3 pcs**  
REF 04757100



Spray clip black without external tube holder

**3 pcs**  
REF 05051000



Spray clip green with external tube holder for Kirschner/Meyer internal cooling system

**3 pcs, for left**  
REF 06946300  
**3 pcs, for right**  
REF 06948300



Spray clip green without external tube holder

**3 pcs, for left**  
REF 06948400  
**3 pcs, for right**  
REF 06949500

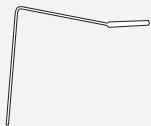

**Coolant tubing for internal cooling through the bur**  
REF 02610500



**Y-manifold**  
**3 pcs**  
REF 06016400

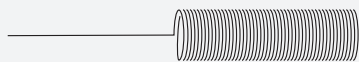

**Short nozzle cleaner**  
REF 02015101

Parts available after sale

## Surgical straight and contra-angle handpieces



1:1, straight, lever chuck system, for surgical burs and cutters Ø 2.35 mm (also system Stryker)

**S-11 LG**  
REF 30057000



**S-11**  
REF 30056000



1:1, angled, slim, lever chuck system, for surgical burs and cutters Ø 2.35 mm (also system Stryker)

**S-9 LG**  
REF 30054000



**S-9**  
REF 30053000



1:1, straight, lever chuck system, for surgical burs and cutters Ø 2.35 mm (also system Stryker)

**S-15**  
REF 30060000



1:1, angled, slim, lever chuck system, for surgical burs and cutters Ø 2.35 mm

**S-10**  
REF 30059000



1:2, angled, slim, lever chuck system, for surgical burs and cutters Ø 2.35 mm

**S-12**  
REF 30061000



1:2, lever chuck system, for surgical burs and cutters, Ø 2.35 mm

**S-16**  
REF 30411000



20:1, twist chuck system, for zygoma burs, surgical burs and cutters, Ø 2.35 mm

**SZ-75**  
REF 30095000

Surgical handpieces

Oral surgery & Implantology

Parts available after sale









Oral surgery & Implantology



# Surgical saw handpieces

## Explanation of Symbols

-  reciprocating
-  oscillating
-  sagittal
-  without light
-  external spray
-  thermo washer disinfectable
-  sterilizable



The saw handpieces have been specially designed for conversion osteotomies and bone harvesting. Even after many years of use at maximum speed a high performance is still guaranteed.

## Surgical saw handpieces



3.25:1, Spray clip, nozzle cleaner, spanner

**S-8 R reciprocating**  
REF 10100801



3.4:1, Spray clip, nozzle cleaner, spanner

**S-8 O oscillating**  
REF 10100802



3.25:1, Spray clip, nozzle cleaner, spanner

**S-8 S sagittal**  
REF 10100803

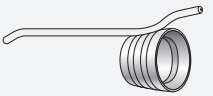

**Coolant tubing for S-8 R, S-8 S**  
REF 04870800



**Coolant tubing for S-8 O**  
REF 04871000



**Spanner to change the saw blades**  
REF 04740200

## Surgical saw handpieces



Reciprocating, crosswise, forward/reverse cutting direction, for saw handpiece S-8 R

**R-15, length approx. 15 mm**  
1 pc REF 04726000  
5 pcs REF 04800100

**R-20, length approx. 20 mm**  
1 pc REF 04725900  
5 pcs REF 04800000

**R-30, length approx. 30 mm**  
1 pc REF 04725700  
5 pcs REF 04799900



Oscillating, cutting direction 90° to the axis, depth gauge on the saw blade (2.5 mm gradations), for saw handpiece S-8 O

**O-8, width approx. 8 mm**  
REF 04800500

**O-15, width approx. 15 mm**  
REF 04800400



Sagittal, cutting direction parallel to the axis, depth gauge on the saw blade (2.5 mm gradations), for saw handpiece S-8 S

**S-6, width approx. 6 mm**  
1 pc REF 04726200  
5 pcs REF 04800300

**S-10, width approx. 10 mm**  
1 pc REF 04726100  
5 pcs REF 04800200

Saw blades

# Piezomed



piezomed

Piezomed facilitates the surgeon's work: thanks to innovative Ultrasound technology, only bone substance is resected with high precision. The surrounding soft tissue remains uninjured. A noticeable relief for the patient: less pain, quicker healing!

**Piezomed, consists of:**

- › Control unit (100 – 130 V / 220 – 240 V)
- › Foot control S-N1 / S-NW
- › Handpiece with 1.8 m cable or
- › Handpiece with 3.5 m cable and clips
- › Irrigation tubing set
- › Mains cable
- › Motor support
- › Stand
- › Instrument changer
- › Sterilization Cassette
- › Instrument kit „Bone“

**SA-320 with handpiece 1,8 m cable, foot control S-N1**  
REF 30078000



**SA-320 with handpiece 1,8 m cable, without foot control, without Instrumentkit Bone, without sterilisation cassette**  
REF 30078003



Implantmed Sets



**Handpiece**  
1.8 m cable incl. 5 clips  
REF 06985000

**Handpiece**  
3.5 m cable incl. 10 clips  
REF 07159200



**Foot control S-N1**  
REF 07004400

**Handle for foot control S-N1, S-N2, S-NW**  
REF 04653500



**Foot control S-NW with SPI dongle**  
REF 30264001



**SPI dongle**  
(Implantmed SI-923, SI-915 (2011), Elcomed SA-310, Piezomed SA-320)  
REF 07795800

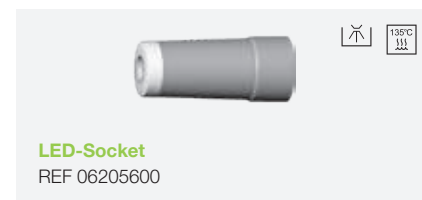

**LED-Socket**  
REF 06205600

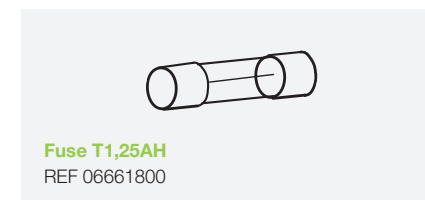

**Fuse T1,25AH**  
REF 06661800



**Transportation case Piezomed SA-320**  
REF 07945930



**Cassette for Piezomed**  
REF 07172900



Parts available after sale

Oral surgery & Implantology

Oral surgery & Implantology



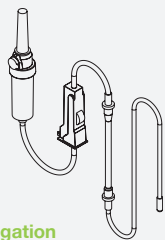

**Disposable irrigation tubing set for motor with 1,8 m cable, 6pcs, 2,2 m**  
REF 04363600

**Disposable irrigation tubing set for motor with 3,5 m cable, 6 pcs, 3,8 m**  
REF 04364100

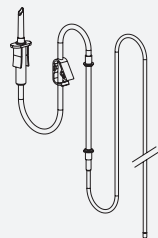

**Sterilizable irrigation tubing set for motor with 1,8 m cable, 1 pcs, 2,2 m**  
REF 04719400



**Instrument stand**  
REF 07134900



**Instrument kit „Bone“**  
consists of instruments:  
**B1, B2R, B2L, B3, B4, B5**  
REF 07173100



**Instrument kit Sinus „SPECIAL“**  
consists of instruments:  
**S1, S2, S3, S4, S5**  
REF 07173200



**Instrument kit „Endo“**  
consists of instruments:  
**R1D, R2RD, R2LD, R3D, R4RD, R4LD**  
REF 07173300



**Instrument kit „Paro“**  
consists of instruments:  
**P1, P2RD, P2LD**  
REF 07173400



**Instrument kit „EX“**  
consists of instruments:  
**EX1, EX2**  
REF 07173500



**Instrument kit „Implant/Crestal P“**  
consists of instruments:  
**I1, I2P, I3P, I4P, Z25P, Z35P**  
REF 07997110

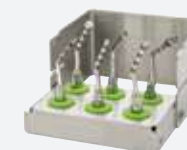

**Instrument kit „Implant/Crestal A“**  
consists of instruments:  
**I1, I2A, I3A, I4A, Z25P, Z35P**  
REF 07997090



Fine-toothed instrument for fine cuts, with little bone loss when harvesting bone blocks.

**Instrument B1**  
REF 05530100



Fine-toothed instrument for horizontal cuts with little bone loss in hard-to-reach areas. Right-curved models available.

**Instrument B2R**  
REF 06958600



Fine-toothed instrument for horizontal cuts with little bone loss in hard-to-reach areas. Left-curved models available.

**Instrument B2L**  
REF 05544400



Sharp instrument for modelling and contouring the bone surface, as well as for collecting bone chips.

**Instrument B3**  
REF 05542100



Sharp chisel for splitting the alveolar ridge.

**Instrument B4**  
REF 05543800



Sharp scraper for collecting bone chips and detaching bone flaps.

**Instrument B5**  
REF 05534500



Special saws for fine and deep cuts in record time. Also for separating tooth roots and for root-tip resections.

**Instrument B6**  
REF 07022500



Special saws for fine and deep cuts in record time. Also for separating tooth roots and for root-tip resections.

**Instrument B7**  
REF 07022600



Diamond-coated instrument for preparation of a bone flap for lateral sinus floor augmentation and for crown edge extensions.

**Instrument S1**  
REF 05542900



Instrument with diamond-coated ball for preparation of a bone flap for lateral sinus floor augmentation and for crown edge extensions.

**Instrument S2**  
REF 05534700



Instrument for gentle detachment of the Schneiderian membrane from the bone. The coolant film protects the Schneiderian membrane by means of three coolant openings.

**Instrument S3**  
REF 05508200



Instrument with rounded edges for atraumatic detachment of the Schneiderian membrane.

**Instrument S4**  
REF 05542300



Instrument with rounded edges for atraumatic detachment of the Schneiderian membrane.

**Instrument S5**  
REF 05542800



Straight, diamond-coated instrument for retrograde root canal preparation.

**Instrument R1D**  
REF 05975200



Slightly right-curved, diamond-coated instrument for retrograde root canal preparation.

**Instrument R2RD**  
REF 05991000



Slightly left-curved, diamond-coated instrument for retrograde root canal preparation.

**Instrument R2LD**  
REF 05999400



Angled, diamond-coated instrument for retrograde root canal preparation.

**Instrument R3D**  
REF 05998800



Strongly right-curved, diamond-coated instrument for retrograde root canal preparation.

**Instrument R4RD**  
REF 06005000



Strongly left-curved, diamond-coated instrument for retrograde root canal preparation.

**Instrument R4LD**  
REF 06004700



For removing concretions in the subgingival region. Ideal for treatment of deep, periodontal pockets.

**Instrument P1**  
REF 06067700



Right-curved, diamond-coated tip for periodontal debridement. Especially suitable for open root planing.

**Instrument P2RD**  
REF 06061700



Left-curved, diamond-coated tip for periodontal debridement. Especially suitable for open root planing.

**Instrument P2LD**  
REF 06061800



Instrument for atraumatic tooth extraction to preserve the alveolar bone.

**Instrument EX1**  
REF 06069300



Instrument for atraumatic tooth extraction to preserve the alveolar bone.

**Instrument EX2**  
REF 06071100



Diamond-coated instrument with depth marks for pilot preparation with the correct axial alignment.

**Instrument I1**  
REF 07786800



Diamond-coated instrument for expansion of the pilot hole (Ø 2.5 mm) and for lifting the Schneiderian membrane using a cooling medium.

**Instrument Z25P**  
REF 07785600



Instruments for gradual preparation of the implant bed (2 to 3 mm) up to the desired depth. A = anterior region

**Instrument I2A**  
REF 07797800



Instruments for gradual preparation of the implant bed (2 to 3 mm) up to the desired depth. P = posterior region

**Instrument I2P**  
REF 07788800



Instruments for gradual preparation of the implant bed (2 to 3 mm) up to the desired depth. A = anterior region

**Instrument I3A**  
REF 07885600



Instruments for gradual preparation of the implant bed (2 to 3 mm) up to the desired depth. P = posterior region

**Instrument I3P**  
REF 07887000



Diamond-coated instrument for expansion of the pilot hole (Ø 3.5 mm) and for lifting the Schneiderian membrane using a cooling medium.

**Instrument Z35P**  
REF 07980600



Instruments for preparation of the implant bed (4 mm) up to the desired depth. A = anterior region

**Instrument I4A**  
REF 07889400



Instruments for preparation of the implant bed (4 mm) up to the desired depth.  
P = posterior region

**Instrument I4P**  
REF 07889500



**Instrument changer**  
REF 06276700

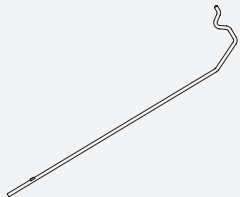

**Stand**  
REF 04005900



**Motor support**  
REF 06177800



**Clips 5pcs for Elcomed SA-310, Piezomed SA-320, Implantmed Plus and Implantmed Classic**  
REF 06290600

**Clips 5 pcs for Implantmed SI-923 / SI-915**  
REF 04019000



**Handle for foot controls**  
REF 04653500



**Nozzle cleaner**  
REF 00636901



- › Your W&H control units in one compact location
- › Space-saving
- › Mobile
- › Dimensions (height x width x depth): 935 x 500 x 450 mm

**Surgical trolley with 3 sockets (European style)**  
REF 07962870

**Cleaning and  
Disinfectant agents for**

- › Surfaces
- › Instruments
- › Suction Systems
- › Automated Reprocessing
- › Hand Care



Mild handwashing lotion for frequent use with pH adjusted and skin protecting substances

- › 1000 ml bottle



**BePro Hand Wash**  
(MOQ 8 units or multiple)  
REF 19500250

**BePro Wash dosage pump**  
REF 19500298



Cleaning and disinfection of non-invasive medical devices and housing of handpieces

- › 120 pieces in refillable plastic tub



**BePro Disinfectant Wipes**  
(MOQ 27 units or multiple)  
REF 19500102

Cleaning and disinfection of non-invasive medical devices and housing of handpieces

- › 1000 ml bottle with spray head



**BePro Disinfectant Spray**  
(MOQ 10 units or multiple)  
REF 19500100

Hygiene lotion for daily frequent use with moisturisers, vitamins, and anti-ageing substances

- › 500 ml bottle with dispenser



**BePro Hand Hygiene**  
(MOQ 30 units or multiple)  
REF 19500105

Greasing skin protection and invisible barrier for skin protection especially when wearing gloves

- › 100 ml tube



**BePro Hand Protect**  
(MOQ 48 units or multiple)  
REF 19500251

Cleaning and disinfection of non-invasive medical devices and housing of handpieces

- › 120 pieces in refill soft pack



**BePro Disinfectant Wipes Refill**  
(MOQ 12 units or multiple)  
REF 19500103

Cleaning and disinfection of non-invasive medical devices and housing of handpieces

- › 5000 ml refill canister



**BePro Disinfectant Spray Refill**  
(MOQ 2 units or multiple)  
REF 19500101  
**Key opener for 5000 ml canister**  
REF 19500197  
**Refill tap for 5000 ml canister**  
REF 19500198

Moisturising cream for intensive skin protection is quickly absorbed and non-greasy

- › 35 ml tube



**BePro Hand Lotion**  
(MOQ 30 units or multiple)  
REF 19500252

Cleaning and disinfection of large surfaces in dental practices (e.g., floor, door, handle, bathroom, locker room, etc.)

- › 1000 ml bottle with dosing cap



**BePro Disinfectant Concentrate**  
(MOQ 10 units or multiple)  
REF 19500104

Pre-disinfection of surgical and dental instruments (NO handpieces). Suitable for both soaking bath and ultrasonic bath

- › 2000 ml bottle with dosing cap



**BePro Disinfectant I**  
(MOQ 6 units or multiple)  
REF 19500106

Innovative internal dosing system  
Stackable design and optimized ergonomics,  
Medical Device Class I  
Thermo washer disinfectable

- › 3000 ml basin



**BePro Soaking Bath**  
(to be used with 19500106)  
REF 19500300

Pre-disinfection of surgical and dental rotary instruments (NO handpieces). Suitable for both soaking bath and ultrasonic bath

- › 1000 ml bottle with dosing cap



**BePro Disinfectant R**  
(MOQ 10 units or multiple)  
REF 19500107

- › Specific plastic material compatible with disinfectants
- › Inner basket designed for small items
- › Possibility to add burs without removing the lid



**BePro Mini bath**  
(MOQ 20 units or multiple)  
(to be used with 19500107 or 19500108)  
REF 19500301

Pre-disinfection of surgical and dental rotary instruments (NO handpieces). Suitable for both soaking bath and ultrasonic bath

- › 5000 ml refill canister



**BePro Disinfectant R**  
(MOQ 2 units or multiple)  
REF 19500108

**Dosage pump for 5000 ml canister**  
REF 19500199

Suction system chemicals

Daily cleaning and disinfection of dental suction system w/wo amalgam separator

- › 5000 ml canister



**BePro Suction CD**  
(MOQ 2 units or multiple)  
REF 19500254

Weekly acid contra-cleaning and maintenance of dental suction system w/wo amalgam separator

- › 5000 ml canister



**BePro Suction CD**  
(MOQ 2 units or multiple)  
REF 19500253

- › 2000 ml capacity



**BePro Suction Mixing Cup**  
(to be used with 19500253 and 19500254)  
REF 19500299

**BePro Mixing cup add. connector**  
(to be used with 19500299)  
REF 19500297



teon

# Thermal washer disinfector



Teon is a highly efficient thermal washer disinfector.



#### Teon, consists of:

Teon is available without interior, so you can tailor the device exactly to your needs. For more information, see the accessories list.

**ZER (Germany, Austria, Netherlands, Belgium, France, Switzerland, Italy, Slovenia, Croatia)**

REF 19860010

**SER (Spain, Portugal)**

REF 19860020

**OER (Hungary)**

REF 19860030

**NER (Denmark, Finland, Norway, Sweden)**

REF 19860060

**GB (Great Britain, Ireland)**

REF 19860110

**BG (Bulgaria)**

REF 19860140

teon +

# Thermal washer disinfector



Teon +, the premium W&H thermal washer disinfector, ensures the most demanding clinics an excellent automatic cleaning system for instruments, including handpieces.



#### Teon +, consists of:

Complete your Teon + with the interior you really need. The device is sold empty, but can be equipped to your individual needs. For more information, see the accessories list.

**ZER (Germany, Austria, Netherlands, Belgium, France, Switzerland, Italy, Slovenia, Croatia)**

REF 19870010

**NER (Denmark, Finland, Norway, Sweden)**

REF 19870060

**GB (Great Britain, Ireland)**

REF 19870110

**BG (Bulgaria)**

REF 19870140

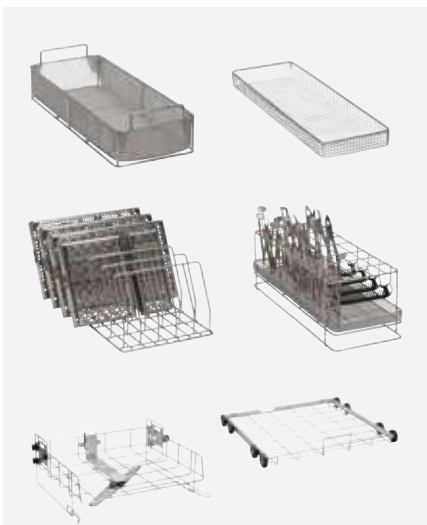

Accessories package includes the perfect range of basic equipment.

**Starter pack:**

- > A102 Upper basket
- > E430/1 Insert 1/3 mesh tray
- > A151 Lower basket/open front
- > E379 Insert 1/2 mesh tray
- > E337/1 Insert 2/5
- > E523 Insert 1/2

REF 19721439

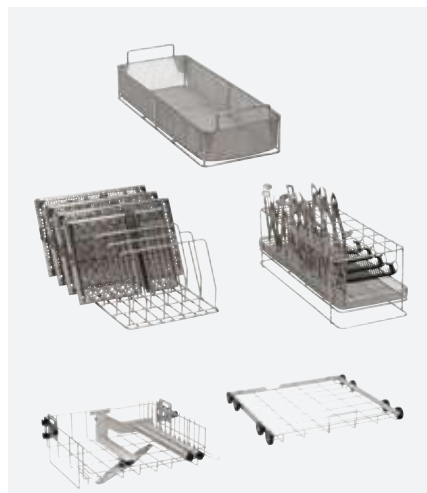

Accessories package complemented by an additional equipment perfectly and particularly suitable for handpieces.

**Injector pack:**

- > A151 Lower basket/open front
- > E379 Insert 1/2 mesh tray
- > E337/1 Insert 2/5
- > E523 Insert 1/2
- > A105/1 Upper basket/injectors unit
- > A836 Dental nozzle set

REF 19721440



**A102 Upper basket**  
REF 19721400



**A105/1 Upper basket/injectors unit**  
REF 19721455

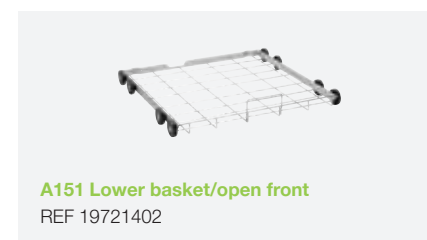

**A151 Lower basket/open front**  
REF 19721402



**XKM RS232 10 Med Serial module**  
REF 19721432



**XKM 3000L Med Ethernet module**  
REF 19721433



**A801 Adapter**  
REF 19721405

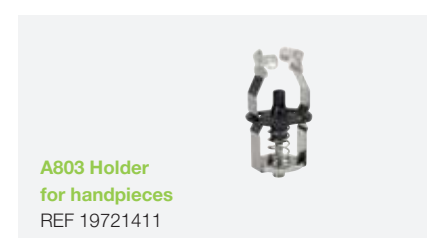

**A803 Holder for handpieces**  
REF 19721411

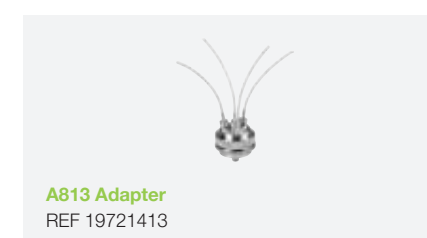

**A813 Adapter**  
REF 19721413



**A814/1 Adapter**  
REF 19721466

Parts available after sale

Sterilization, Hygiene & Maintenance

Sterilization, Hygiene & Maintenance



**A815 Nozzle**  
REF 19721414

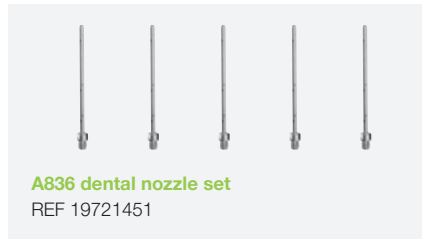

**A836 dental nozzle set**  
REF 19721451



**A832 Injector nozzle**  
REF 19721457



**A816 Injector nozzle**  
REF 19721459



**A834 Injector nozzle**  
REF 19721458



**A819 Irrigation sleeve**  
REF 19721462



**A817 Irrigation sleeve**  
REF 19721460



**E336 Irrigation sleeve**  
REF 19721456



**A818 Caps for sleeve**  
REF 19721461



**E476 Adapter**  
REF 19721425



**ADS1 Adapter silicone**  
REF 19721408



**ADS2 Adapter silicone**  
REF 19721409



**ADS3 Adapter silicone**  
REF 19721410



**AUF1 Adapter**  
REF 19721406



**A800 Central filter**  
REF 19721404

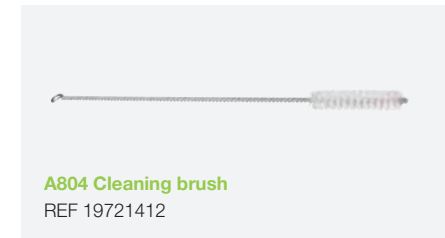

**A804 Cleaning brush**  
REF 19721412



**E130 Insert 1/2 for 10 trays**  
REF 19721415



**E131/1 Insert**  
REF 19721416



**E198 Insert 1/2**  
REF 19721419



**E146 Insert 1/6**  
REF 19721417



**E523 Insert 1/2**  
REF 19721429



**E339/1 Insert**  
REF 19721437



**E197 Insert 1/6 mesh tray**  
REF 19721418

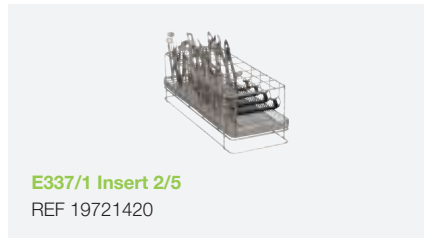

**E337/1 Insert 2/5**  
REF 19721420



**E363 Insert 1/6 mesh tray**  
REF 19721421



**E468 Insert 1/4 mesh tray w/lid**  
REF 19721465



**E379 Insert 1/2 mesh tray**  
REF 19721422



**E430/1 Insert 1/3 mesh tray**  
REF 19721423



**E378 Insert 1/1 mesh tray**  
REF 19721464



**E147/1 Insert 1/2**  
REF 19721463

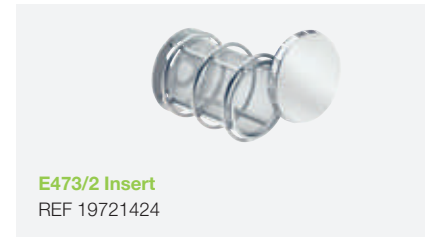

**E473/2 Insert**  
REF 19721424



**E520 Insert**  
REF 19721426

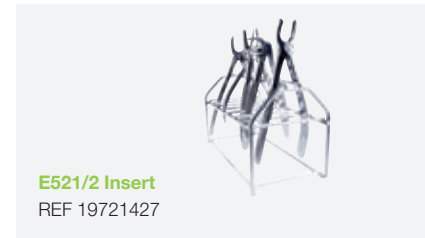

**E521/2 Insert**  
REF 19721427

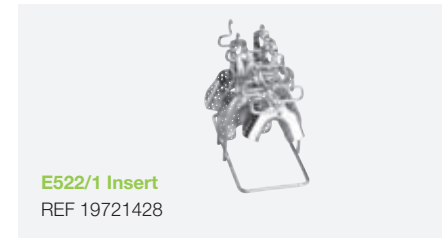

**E522/1 Insert**  
REF 19721428



**DOS K85/1 200-240V 50Hz**  
REF 19721435  
**DOS K85/1 200-240V 60Hz**  
REF 19721443



**Multidem XL**  
large water supply to a number of thermal washer disinfectors  
REF 19721441  
**Multidem XL resin cartridge**  
REF 19721445

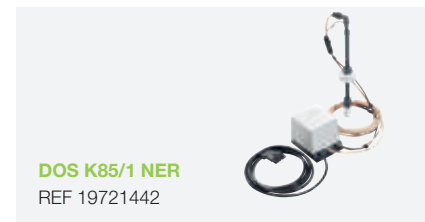

**DOS K85/1 NER**  
REF 19721442



**UG 30-60/60-85 Base plinth**  
REF 19721438

Tri-enzymatic detergent with neutral pH (no neutraliser is required), recommended for handpieces

- › 5000 ml canister



**BePro Cleaner TE**  
(MOQ 3 units or multiple)  
REF 19500200

To be used together with alkaline detergents to restore PH to optimal values.

- › 5000 ml canister



**BePro Neutraliser C**  
(MOQ 3 units or multiple)  
REF 19500202

Alkaline detergent (neutraliser is required), do not use with handpieces

- › 5000 ml canister



**BePro Cleaner MA**  
(MOQ 3 units or multiple)  
REF 19500201

Supports and improves drying phase of the load

- › 1000 ml bottle



**BePro Rinse Aid**  
(MOQ 6 units or multiple)  
REF 19500203





# Assistina Twin with Quick Connect by W&H



**Oil service  
without waiting.**

The Assistina Twin with Quick Connect by W&H is unique among maintenance devices: with its innovative dual-chamber system, record time lubrication and the environmentally friendly Care Set, it impresses all along the line.



**Assistina Twin with Quick Connect by W&H, consists of:**

- › REF 02697000 Air supply hose 2 m
- › REF 07477500 Power supply unit
- › REF 07484000 Twin Care Set

**Assistina Twin MB-302**  
REF 30310000

**Assistina Twin MB-302 + 2 Quick ISO adaptors**  
REF 30310001

**Assistina Twin MB-302 + 2 Quick RM adaptors**  
REF 30310002

**Assistina Twin MB-302 + 1 Quick ISO + 1 Quick RM adaptors**  
REF 30310003



Parts available after sale



Accessories



# Assistina One



## Speed up maintenance operation

The entire lubrication and spray channel cleaning process only takes 18 seconds, making the Assistina One the fastest maintenance solution in its class. Together with Quick Connect by W&H and convenient cartridge management, the Assistina One is a modern maintenance solution for dental practices with high standards in handpiece care.

**Assistina ONE with Quick Connect by W&H, consists of:**

- › REF 02697000 Air supply hose 2 m
- › REF 08064970 One Care Set

**Assistina ONE + 1 Quick ISO adaptor**

REF 30398001

**Assistina ONE + 1 Quick RM adaptor**

REF 30398002

**Assistina ONE + 1 Quick RM + 1 Quick ISO adaptors**

REF 30398003



**Rotating window**  
REF 08029230



**Filter compartment cover**  
REF 08035870

**ONE Care Set, consists of:**

- › W&H Activefluid, MC-302
- › W&H Service Oil F1, MD-302
- › HEPA filter

**ONE Care Set**  
REF 08064970



# Assistina 301 plus



Maintenance unit for automatic internal cleaning of spray channels and lubrication of straight and contra-angle handpieces, turbine handpieces, air motors, air scalers, as well as W&H surgical straight and contra-angle handpieces.

**Assistina 301 plus**  
**with base adaptor REF 02685000**  
 REF 00030140

**Set Assistina, consists of:**

- › REF 00030140 Assistina 301 plus
- › REF 02680500 cleaning and lubricating set
- › REF 02685000 base adaptor

REF 00030125



**W&H Service Oil F1**  
**MD-500 (oil bottle, 500 ml)**  
 REF 02675910



**W&H cleaning liquid**  
**MC-1000 (1000 ml)**  
 REF 02680200



**Cleaning and lubricating set, consists of:**

- › MD-500 W&H Service Oil F1
- › MC-1000 W&H cleaning liquid

REF 02680500



**Fleece for Assistina 301 plus**  
**20 pcs**  
 REF 02694500



**Filter pack**  
**for Assistina 301 plus**  
 REF 02670500



**Air connection hose 2 m**  
**for Assistina Twin, One and 301 plus**  
 REF 02697000



**Air filter for Assistina Twin, One and 301 plus**  
 REF 02675200



**Waste drawer for Assistina 3x3 and 3x2**  
 REF 06692500



**Air connection hose 2 m**  
**for Assistina 3x3 and 3x2**  
 REF 06700100



**Cover – Assistina 3x3**  
 REF 06691900  
**Cover – Assistina 3x2**  
 REF 06947500



**External cleaning ring**  
**for Assistina 3x3**  
 REF 06692700



For Assistina 3x3 and 3x2

**W&H Activefluid, MC-1100**  
**1 cartridge**  
 REF 06691600  
**W&H Activefluid, MC-1100**  
**1 carton (6 cartridges)**  
 REF 06872300



For Assistina 3x3 and 3x2

**W&H Service Oil F1, MD-200**  
**1 cartridge**  
 REF 06691500  
**W&H Service Oil F1, MD-200**  
**1 carton (4 cartridges)**  
 REF 06872200



Parts available after sale and Accessories

Accessories

Sterilization, Hygiene & Maintenance

## Assistina adaptors

Adaptors for turbine handpieces

Adaptors for straight and contra-angle handpieces

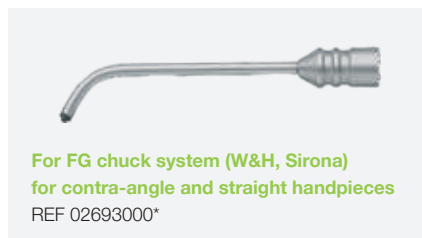

## Assistina adaptors

Assistina Twin and One adaptors



Assistina 301 Plus adaptor



Assistina 3x3, 3x2 adaptor



The KaVo Multiflex® coupling 465 RN and the Bien Air Unifix-Traplite quick coupling 104.23.05. can be fitted on to the base adaptor REF 02685000. Regarding other brands, we recommend you to consult the manufacturer.



# Service Oil F1

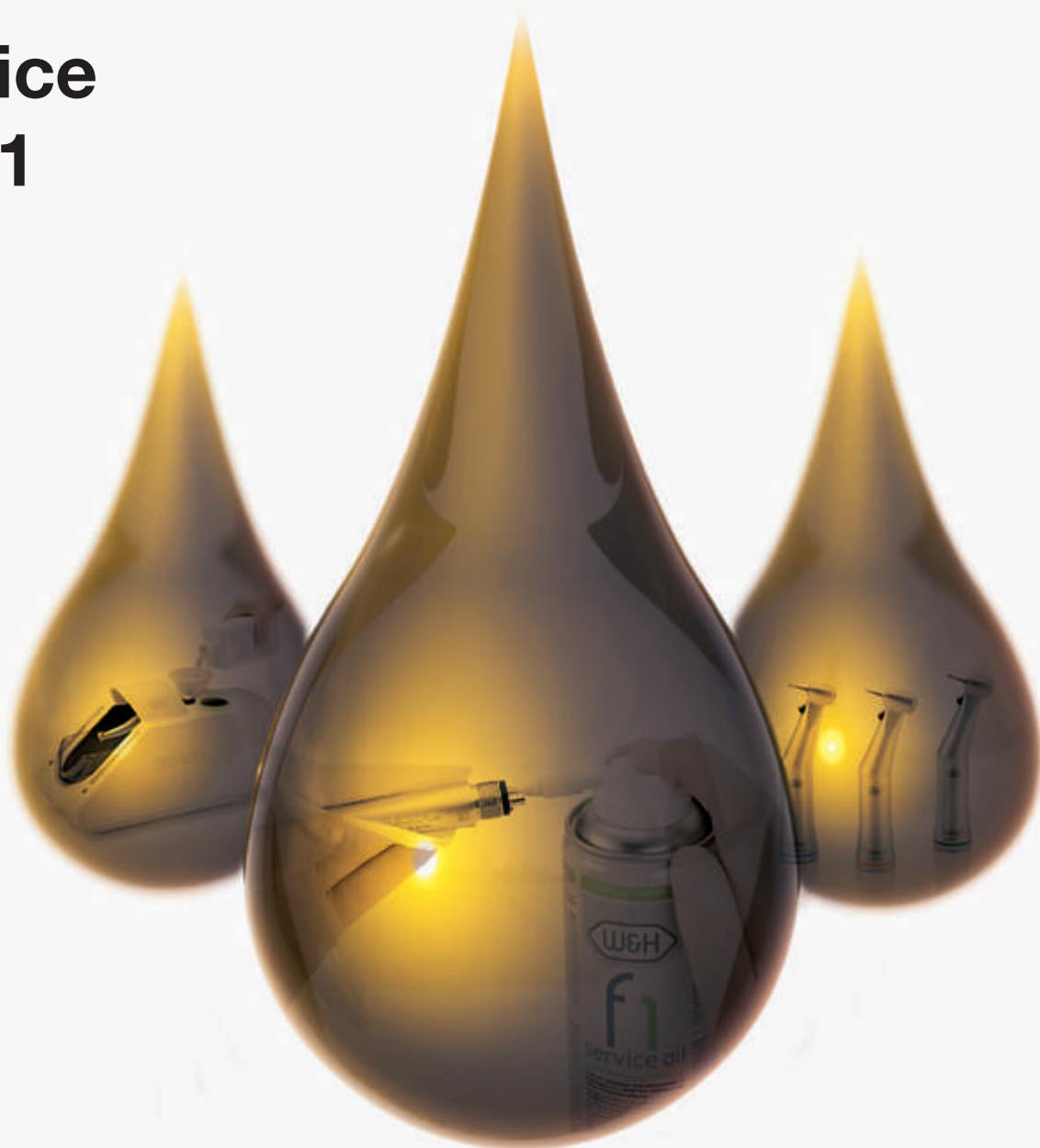

f1 service  
oil

W&H Service Oil F1 is a synthetic oil of maximum purity, which has been specially developed for maintenance of W&H turbine handpieces, straight and contra-angle handpieces, surgical instruments, air scalers and air motors.





Oil spray can, package of 6 cans

MD-400 (400 ml, 6 pcs)

REF 10940021

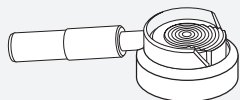

For contra-angle and straight handpieces

REF 02038200

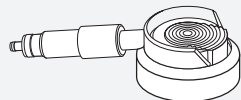

For W&H turbine handpieces, air motors and air scalers with Roto Quick connection

REF 02229200

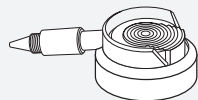

For turbine handpieces and air motors with fixed connection

REF 02036100

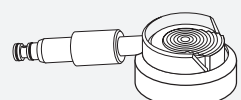

For products with Multiflex connection

REF 04396100

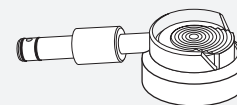

For Alegra turbine handpieces with Sirona connection

REF 05908000

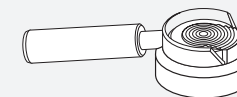

For Alegra turbine handpieces with NSK Mach connection

REF 05773300

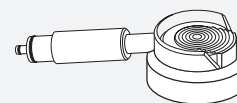

For Alegra turbine handpieces with Bien Air Unifix connection

REF 05772000

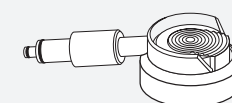

For Alegra turbine handpieces with NSK QD-J connection

REF 05907800

Keep spray caps with nozzles for oil spray cans in stock. They can be re-used with every new can.

lisa

# W&H steam sterilizer



## Lisa, consists of:

- › Reversible rack
- › 5 aluminium trays
- › Drain tube
- › Tray holder
- › 8 GB USB drive
- › Door opening tool
- › Factory test

## Lisa 17

REF 19931180

## Lisa 22

REF 19932180



W&H Lisa type-B steam sterilizer, for the safe sterilization of solid, hollow and porous load in accordance with the EN 13060.

lara<sup>XL</sup>

# W&H steam sterilizer



## Lara XL consists of:

- > Chamber rack
- > 6 aluminium trays
- > Drain tube
- > Tray holder
- > 8 GB USB drive
- > Door opening tool
- > Factory test

## Lara XL 28

REF 19933110



W&H Lara XL type-B steam sterilizer, for the safe sterilization of solid, hollow and porous load in accordance with the EN 13060.

lara

# W&H steam sterilizer



### Lara, consists of:

- › Reversible rack
- › 3 aluminium trays
- › Drain tube
- › Tray holder
- › 8 GB USB drive
- › Door opening tool
- › Factory test

### Lara 17

REF 19941120



### Lara 22

REF 19942120

W&H Lara type-B steam sterilizer, for the safe sterilization of solid, hollow and porous load in accordance with the EN 13060.

lina

# W&H steam sterilizer



- Lina, consists of:**
- › Reversible rack
  - › 3 aluminium trays
  - › Drain tube
  - › Tray holder
  - › 8 GB USB drive
  - › Door opening tool
  - › Factory test

**Lina 17 50HZ**  
REF 19951130

**Lina 17 60HZ**  
REF 19951230

**Lina 22 50HZ**  
REF 19952130

**Lina 22 60HZ**  
REF 19952230

**Lina 22 50/60 HZ 110V**  
REF 19952330

**Lina 22 50/60 HZ AWF 110V**  
REF 19952331



**With automatic water filling  
and USB option:**

**Lina 17 50HZ AWF**  
REF 19951131

**Lina 17 60HZ AWF**  
REF 19951231

**Lina 22 50HZ AWF**  
REF 19952131

**Lina 22 60HZ AWF**  
REF 19952231

W&H Lina type-B steam sterilizer, for the safe sterilization of solid, hollow and porous load in accordance with the EN 13060.

lyla

# W&H steam sterilizer



### Lyla, consists of:

- › Reversible rack
- › 3 aluminium trays
- › Drain hose
- › Tray holder
- › 8 GB USB stick
- › Door opening tool
- › Factory test

### Lyla 17 50 HZ

REF 19951150

### Lyla 17 60 HZ

REF 19951250

### Lyla 22 50 HZ

REF 19952150

### Lyla 22 60 HZ

REF 19952250

### Lyla 22 50/60 HZ 110V

REF 19952350



With automatic water filling, USB option  
and conductivimeter

### Lyla 17 50 HZ AWF

REF 19951154

### Lyla 22 50 HZ AWF

REF 19952154

W&H Lyla type-S steam sterilizer, designed, certified and validated in accordance with the EN13060.

lexa

# W&H steam sterilizer



### Lexa, consists of:

- > Reversible rack
- > 4 aluminium trays
- > Drain tube
- > Tray holder
- > 8 GB USB stick
- > Door opening tool
- > Factory test

### Lexa 100-125V

REF 19943401

### Lexa 200-240V

REF 19943101



W&H Lexa steam sterilizer, for the safe sterilization of solid, hollow and porous load in accordance with ST55.



# Activation Code system for sterilizers



The innovative upgradability system offers you a cost-efficient, rapid and customized opportunity to activate additional features to reflect your practice needs or comply with future requirements

Automatically adapts the cycle time to the mass of the load



**Activation code Performance (Lara)**  
REF 19730070

For enabling EN13060 compliant cycles



**Activation code B cycles (Lyla)**  
REF 19730074

For quick sterilization of unwrapped instruments, including handpieces



**Activation code Fast Cycle (Lara XL, Lara and Lina)**  
REF 19730071

Allows to exactly know which instruments are sterilized and link them to a specific cycle



**Activation code EliTrace (Lara XL, Lexa and Lisa 2015)**  
REF 19730075

For user identification and load release confirmation



**Activation code Traceability (Lara, Lina and Lyla)**  
REF 19730072

All the benefits of Activation Code system in one go



**Activation code All in One**  
REF 19730004 (Lara)  
REF 19730013 (Lina)  
REF 19730076 (Lyla)

For the digital cycle documentation to save cycle directly on PC



**Activation code Remote Data Storage (Lina and Lyla)**  
REF 19730073



Together with the EliSafe label printer, the connection kit is needed

**New EliSafe label printer**  
REF 19721109



USB connection cable + 1 roll of 2.100 labels + 1 wax/resin ribbon + activation code instructions

**EliSafe connection kit**  
REF 19721123



**EliSafe consumables kit**  
2 rolls of 2.100 labels and 2 wax/resin ribbons  
REF A810500X



**Barcode scanner**  
REF 19721132



**Seal<sup>2</sup>**  
pouch sealing device, with double roll-holder, produces 12mm seals  
REF 19722101  
110 Volt Version  
REF 19722102



**SealVal<sup>2</sup>**  
REF 19722103

Accessories

Sterilization, Hygiene & Maintenance

**EliReel**

Sterilization reels (price per roll)

**5.5cm x 200m (MOQ 8 units or multiple)**  
REF 19500000

**7.5cm x 200m (MOQ 8 units or multiple)**  
REF 19500001

**10cm x 200m (MOQ 4 units or multiple)**  
REF 19500002

**15cm x 200m (MOQ 4 units or multiple)**  
REF 19500003



**20cm x 200m (MOQ 2 units or multiple)**  
REF 19500004

**25cm x 200m (MOQ 2 units or multiple)**  
REF 19500005

**30cm x 200m (MOQ 2 units or multiple)**  
REF 19500006



**Seal Check**  
REF T802100X



Thermal printer with cable and adaptor

**Sprint**  
REF 19721141



**Roll of thermal paper for Sprint**  
REF A810504X



**Standard paper roll, 57 mm for Print**  
REF A700140X

Accessories

W&H traceability options

W&H traceability options

Sterilization, Hygiene & Maintenance



**Cartridge for Print**  
REF A700103X



**Remote Wi-Fi kit (USB dongle)**  
REF 19721136  
**Remote Wi-Fi kit (USB dongle) for North American market**  
REF 19721137



**Ethernet cable (LAN) 3 m**  
REF A801500X

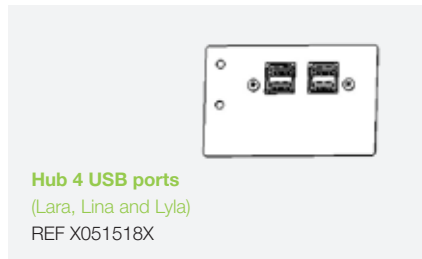

**Hub 4 USB ports**  
(Lara, Lina and Lyla)  
REF X051518X

W&H traceability options

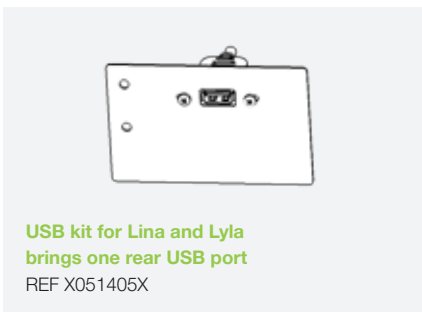

**USB kit for Lina and Lyla**  
brings one rear USB port  
REF X051405X

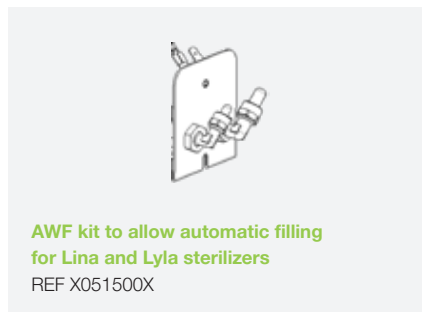

**AWF kit to allow automatic filling**  
for Lina and Lyla sterilizers  
REF X051500X

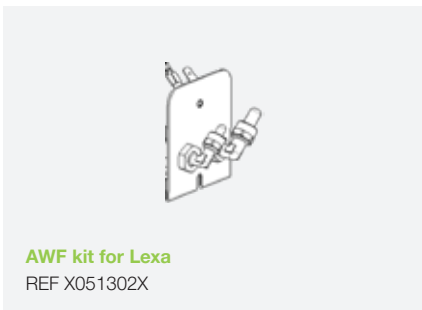

**AWF kit for Lexa**  
REF X051302X

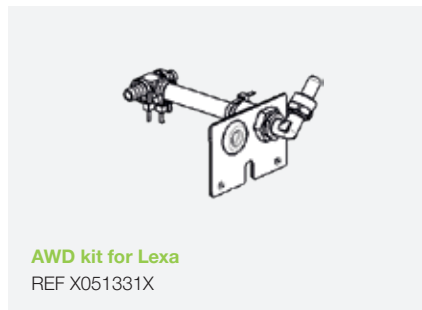

**AWD kit for Lexa**  
REF X051331X

W&H traceability options

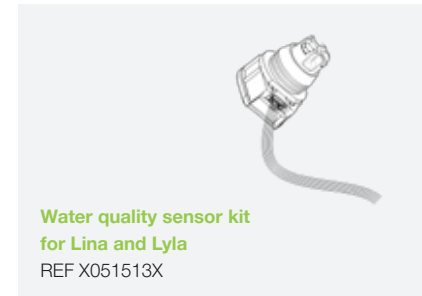

**Water quality sensor kit for Lina and Lyla**  
REF X051513X



**Multidem C27**  
Water supply for W&H or other brand sterilizers  
REF 19723112



**Multidem C27 resin cartridge**  
REF A812016X



**New Osmo**  
large amount of water to supply multiple sterilizers simultaneously  
REF 19721134

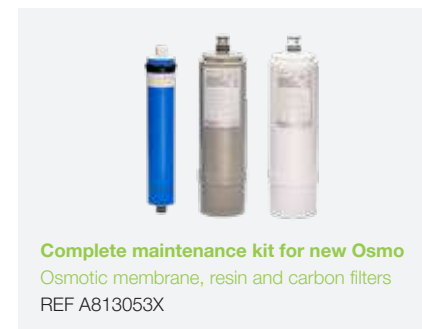

**Complete maintenance kit for new Osmo**  
Osmotic membrane, resin and carbon filters  
REF A813053X



**Filter cartridge maintenance kit for new Osmo**  
Resin and carbon filters  
REF A813030X

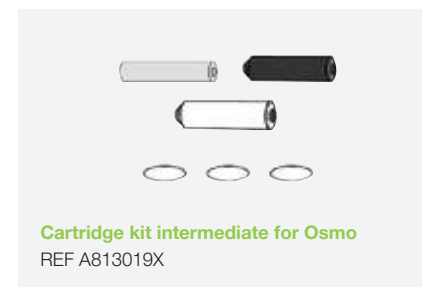

**Cartridge kit intermediate for Osmo**  
REF A813019X

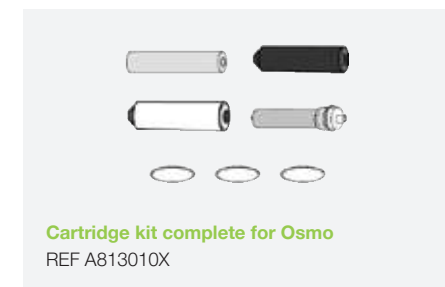

**Cartridge kit complete for Osmo**  
REF A813010X

Water treatments Accessories

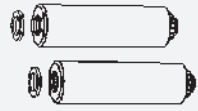

**Resin cartridge for Dem 10 and 32**  
 2 sets of 2 pcs or 2 refills  
 REF A812100X

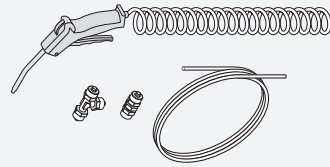

**Water dispenser kit**  
 REF A812018X



**Water distiller**  
 for distillation of tap water,  
 capacity 4 litres  
 REF 19723101

**Dist 3**  
 water quality tester for  
 measuring the conductivity  
 and purity of the water  
 REF A800504X



**Water residue cleaner  
 for Water distiller 500 g**  
 REF H802010X



**Water receiver for Water distiller**  
 REF A811017X



**Activated charcoal  
 sachet for Water distiller**  
 12 pcs  
 REF H802011X



**Drain tube  
 with quick coupling**  
 REF S230900X

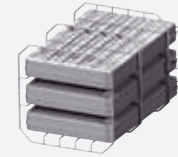

Reversible rack for 5 standard  
 trays or 3 standard cassettes

**For 17 liter sterilizers**  
 REF F523031X

**For 22 liter sterilizers**  
 REF F523032X

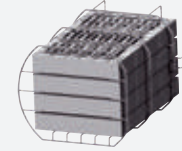

Reversible rack for 4 cassettes

**For 17 liter sterilizers**  
 REF F523012X

**For 22 liter sterilizers**  
 REF F523015X

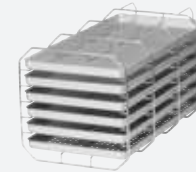

Reversible rack for  
 6 standard trays or  
 3 cassettes

**For 17 liter sterilizers**  
 REF F523033X

**For 22 liter sterilizers**  
 REF F523034X

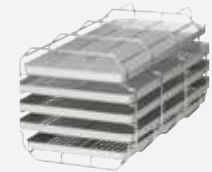

Reversible rack for  
 3 large trays and  
 2 standard trays or 3 cassettes

**For 22 liter sterilizers**  
 REF F523035X

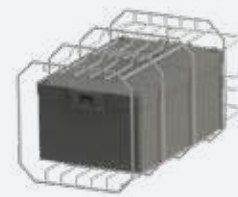

Reversible rack for 6 trays or 1 big container

**For 22 liter sterilizers**  
 REF F523041X

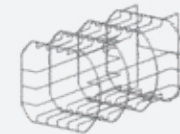

Reversible rack for 3 wide cassettes

**For 17 liter sterilizers**  
 REF F523020X

**For 22 liter sterilizers**  
 REF F523021X

Reversible rack for 2 cassettes

**For 17 liter sterilizers**

REF F523016X

**For 22 liter sterilizers**

REF F523017X

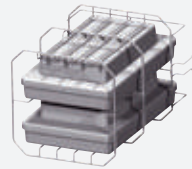

**Rack for 4 large trays and 2 standard trays or mixed containers up to 130 mm of height for Lara XL**

REF F523038X



**Rack for 4 large trays and 1 standard tray or mixed containers up to 170 mm of height for Lara XL**

REF F523042X

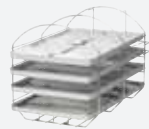

**Rack for 4 large trays or 4 cassettes**

for Lara XL and Lexa

REF F523030X



**Rack for 3 large trays or 4 cassettes**

for Lara XL and Lexa

REF F523036X



**Standard tray for 17 liter sterilizers**

REF F523204X



**Large tray**

For all sterilizers only with rack  
REF numbers F523030X, F523035X, F523036X, F523038X, F523042X  
REF F523211X

**Standard tray for 22 liters sterilizers**

REF F523205X



**Tray holder**

REF F523001X



**Helix test kit by W&H**

1 test and 250 test strips  
REF T800207X

Racks & trays Accessories



**Bowie & Dick test kit**

1 test, minimum order quantity 20 units or multiple  
REF T800002X



**Helix test kit by Browne**

1 test and 250 test strips  
REF T800205X

Other consumables and accessories



**Door seal for Lisa MB**

REF F460503X

**For Lara XL and Lexa**

F460535X



**Door seal**

REF F460504X

Sterilization, Hygiene & Maintenance

Sterilization, Hygiene & Maintenance

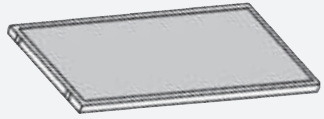

Dust filter for Lina Pro and Lisa until 2015  
REF F364502X

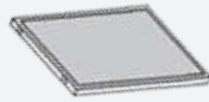

Dust filter for Lisa 2019, Lara, Lina 2020 and Lyla  
REF F364511X



Bacteriological filter  
REF W322400X

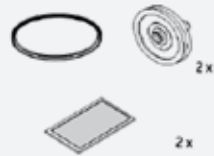

Consumable kit 400-800 cycles for Lina Pro and Lisa until 2015  
REF X050326X

For Lisa 2019, Lara, Lina 2020 and Lyla  
REF X050328X



Lara XL kit 400-800 cycles  
REF X050335X



# Perfecta 300 / 600 / 900



A wide variety of materials, top-level requirements, constantly changing prerequisites – the daily bread of dental technicians. With Perfecta 300 / 600, you have a powerful laboratory device at your fingertips which can be used for a variety of purposes and which can bring your ideas and those of your customers effortlessly to life.





Complete with control unit (230 V or 115 V), mains cable, motor handpiece, handpiece holder and operating controls (optional for foot control) for table and knee control units

**Table control unit**

**LA-323 T (230 V)**

REF 14933000

**LA-315 T (115 V)**

REF 14933001

**Foot control unit**

**LA-323 F (230 V)**

REF 14933200

**LA-315 F (115 V)**

REF 14933201

**Knee control unit**

**LA-323 K (230 V)**

REF 14933100

**LA-315 K (115 V)**

REF 14933101

Perfecta 300



Complete with control unit (230 V or 115 V), mains cable, motor handpiece, handpiece holder and operating controls (optional for foot control) for table and knee control units

**Table control unit**

**LA-623 T (230 V)**

REF 14936000

**LA-615 T (115 V)**

REF 14936001

**Foot control unit**

**LA-623 F (230 V)**

REF 14936200

**LA-615 F (115 V)**

REF 14936201

**Knee control unit**

**LA-623 K (230 V)**

REF 14936100

**LA-615 K (115 V)**

REF 14936101

Perfecta 600



**Operating controls  
LA-3 D for Perfecta 300**

REF 05127000



**Operating controls  
LA-6 D for Perfecta 600**

REF 05243200



**Motor handpiece  
without cable LA-66**

REF 05201200



**Motor „E-type“ without cable  
LA-3 E (only for Perfecta 300)**

REF 05138800

**Motor cable 1.8 m  
for Perfecta 300**

REF 05114900

**Motor cable 1.8 m  
for Perfecta 600**

REF 05116500

Accessories for Perfecta 300 / 600



Complete with control unit (230 V or 115 V), operating controls, mains cable, high-speed handpiece, handpiece holder, hose for air supply, hose for coolant supply (only for types with external coolant supplying)

**With internal coolant supplying:**

**Table control unit LA-923 TT (230 V)**  
REF 14939300  
**LA-915 TT (115 V)**  
REF 14939301

**Knee control unit LA-923 KT (230 V)**  
REF 14939400  
**LA-915 KT (115 V)**  
REF 14939401

**With external coolant supplying**

**Table control unit LA-923 T (230 V)**  
REF 14939000  
**LA-915 T (115 V)**  
REF 14939001

**Knee control unit LA-923 K (230 V)**  
REF 14939100  
**LA-915 K (115 V)**  
REF 14939101

Perfecta 900



**Operating controls LA-9 D**  
REF 05243400



**Milling device adaptor to attach the high-speed handpiece LA-9 to milling devices with 16 or 18 mm diameter LA-9**  
REF 06319400



**Motor handpiece without cable LA-66**  
REF 05201200

**Motor cable 1.8 m for motor handpiece LA-66**  
REF 05116500



**High-speed handpiece without cable LA-9**  
REF 05015900

**Motor cable 1.8 m for high-speed handpiece LA-9**  
REF 05117800

Accessories for Perfecta 900



**Foot-operated starter L-NV**  
REF 05038100



**Handpiece holder**  
REF 03211500



**Wall bracket for operating controls**  
REF 05138000



1:1, technical handpiece for easy technical working, maintenance-free, Twist tension chuck system, only for handpiece burs  
**945**  
REF 14124500

Accessories for Perfecta 300 / 600 / 900

Accessory for E-type version of Perfecta 300

Dental laboratory

Dental laboratory

# Osstell



Osstell® helps you to objectively and non-invasively determine implant stability in order to manage patients with risk factors, avoid unnecessarily long treatment times, and achieve more predictable outcomes.



The Osstell Beacon helps you to objectively and noninvasively determine implant stability.

**Osstell Beacon**  
REF 103000



The SmartPeg™ attaches to the implant and is used together with the measurement instruments Osstell IDx, Osstell Beacon or Osstell ISQ. SmartPegs are single patient use, as reusing them can result in inaccurate readings or damage to the implant.

**SmartPeg/Box (5 pcs)**  
REF 100XXX  
(See SmartPeg Reference List)



The autoclavable SmartPeg Mount is used to carry and connect the SmartPeg to the implant or abutment. SmartPeg mounts comes in boxes of 5.

**SmartPeg Mount (5 pcs)**  
REF 100345



The TestPeg can be used to practice measurements and test an Osstell instrument. Note, the device is not for calibrating, only a guide to check the instruments measure function.

**Osstell TestPeg**  
REF 100381



To use Osstell instruments as effectively as possible it is recommended to have more than one probe, it makes it easier to autoclave between patients. The length including cable is 150cm.

**Osstell ISQ Probe**  
REF 100501



Power supply with an adapter for ac/dc outlet. The use of any other power supply might cause damage to the instrument.

**Power Supply IDx**  
REF 100613



The Osstell Key works in combination with the Osstell Gateway program, installed on a PC/laptop, to transfer measurements from the Osstell Beacon to the user's account in OsstellConnect.

**Osstell Key**  
REF 100710



You should use this USB cable for charging the Osstell Beacon.

**Beacon USB Cable, C**  
REF 100709

# Built-in Solutions



United under the term Built-in Solutions, W&H offers a range of drive solutions that can be integrated in dental units. This makes it possible to equip your treatment units with new functionalities and innovative drives, thereby customizing them to suit your personal requirements.

As always, the highest level of treatment efficiency, ergonomics and maximum comfort for both the user and patient alike are at the heart of W&H Built-in Solutions.

# Primea Advanced Air



- › AC-1.0 Advanced Air Controller + AD-1.0 Analog-digital converter
- › Supply hose VA-6
- › Air supply hose Ø 8 mm
- › 2 connection sets (pneumatic and electric)
- › RQ-24
- › RG-97 L
- › Display D-2.0 A

**Advanced Air RG-97 L**  
with display basic  
REF 90000141



# Electric motor



- › MC-1.0 E motor controller analogue
- › VE-10 hose
- › EM-12 L electric motor
- › 2 connection sets (pneumatic and electric)

**EM-12 L electric motor with display basic**  
REF 90000139



- › MC-1.0 motor controller analogue
- › VE-10 hose
- › EM-12 L electric motor
- › 2 connection sets (pneumatic and electric)

**EM-12 L electric motor with control knob**  
REF 90000138



- › MC-1.0 motor controller analogue
- › VE-10 hose
- › EM-12 L electric motor
- › 2 connection sets (pneumatic and electric)

**EM-12 L electric motor with display basic**  
REF 90000245



- › MC-2.0 motor controller analogue
- › 2x VE-10 hose
- › 2x EM-12 L electric motor
- › 2 connection sets (pneumatic and electric)

**Dual EM-12 L electric motor with display basic**  
REF 90000224



q-link

# Ultrasonic scaler

## Explanation of Symbols



with light



without light



integrated spray



thermo washer  
disinfectable



sterilizable



- › PC-1.0 piezo controller analogue
- › VP-5 supply hose
- › PB-5 L handpiece with 5x ring LED
- › Electrical connection set
- › Control knob
- › incl. tips:
- › **PB-5 L:** 1x 1U, 1x 2U, 1x 1P
- › **PB-5 L Q:** 1x 1UQ, 1x 2UQ, 1x 1PQ
- › **PB-5 L S:** 1x 1US, 1x 2US, 1x 1PS

**Piezo Scaler PB-5 L**  
(with W&H / EMS / Mectron  
standard thread)

REF 90000251

**Piezo Scaler PB-5 L Q**  
(with W&H Q-link - quick  
connection)

REF 90000252

**Piezo Scaler PB-5 L S**  
(with W&H/Satelec/NSK thread)

REF 90000294



- › PC-1.0 piezo controller analogue
- › Supply hose
- › PB-3 handpiece
- › VP-3 supply hose
- › Electrical connection set
- › Control knob
- › incl. tips
- › PB-3: 1x 1U, 1x 1P
- › PB-3 S: 1x 1US, 1x 1PS

**Piezo scaler PB-3**  
(with W&H / EMS / Mectron  
standard thread)

REF 90000149

**Piezo scaler PB-3 S**  
(with W&H/Satelec/NSK thread)

REF 90000302



Scope of application depends on Ultrasonic tips used.  
All scaler tips with tip exchanger with torque limitation.





# Contact us

## **W&H Dentalwerk Bürmoos GmbH**

Ignaz-Glaser-Straße 53, Postfach 1

5111 Bürmoos, **Austria**

**t** + 43 6274 6236-0

**f** + 43 6274 6236-55

office@wh.com

**wh.com**

---

## **W&H Sterilization Srl.**

Via Bolgara, 2

24060 Brusaporto (BG), **Italy**

**t** + 39 035-66 63 000

**f** + 39 035-50 96 988

office.sterilization@wh.com

**wh.com**